

TYPE "A"

TYPE "D"

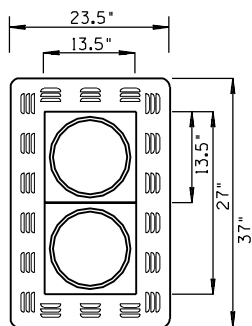
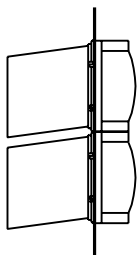
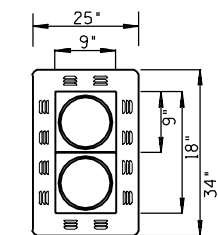
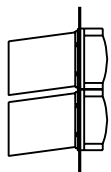

TYPE "B"

TYPE "E"

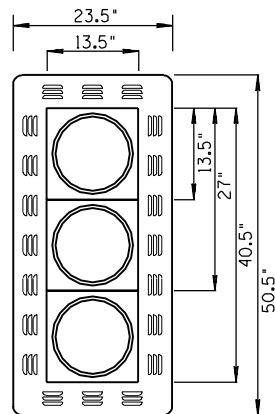
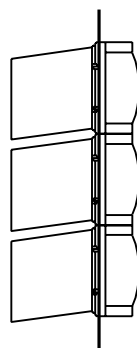
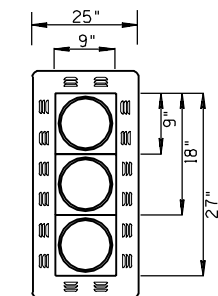
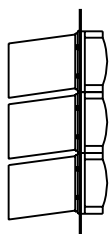

TYPE "C"

TYPE "F"

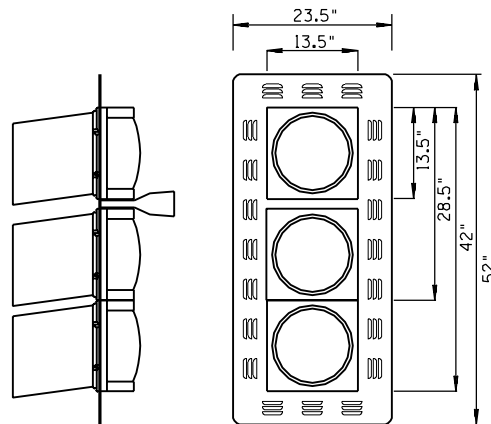

TYPE "F"
(WITH ELEVATOR PLUMBIZER)

NOTES:

1. All materials and construction shall conform to the requirements of the Specifications.
2. All dimensions shown are nominal.
3. Backplates shall be continuous with no open gaps.
4. All signal indications, except the yellow ball, shall be LED modules.
5. All Non-LED lenses shall be Glass.
6. All Backplates shall be Louvered.



PLAN SYMBOL

DESIGN APPROVED	SIGNATURE	ARIZONA DEPT. OF TRANSPORTATION INTERMODAL TRANSPORTATION DIVISION TRAFFIC SIGNALS & LIGHTING STANDARD DRAWINGS	REV.
APPROVED FOR DISTRIBUTION		SIGNAL FACES WITH BACKPLATES	DRAWING NO. T.S. 8-1
ON FILE			