

**DETAIL "A"  
POLE TOP DETAIL**

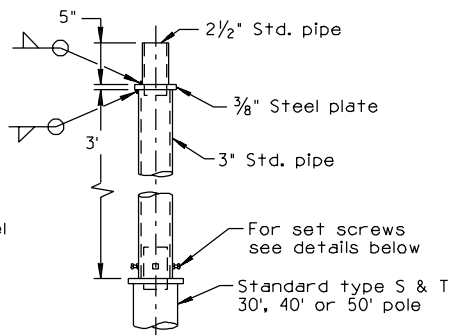

**DETAIL "B"  
POLE EXTENSION**

After bracket has been installed on pole tenon, drill 3/8" hole through bracket and tenon. Install 3/8" x 4 1/2" hex head cadmium plated bolt, nut and washer.

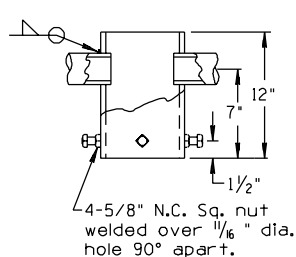
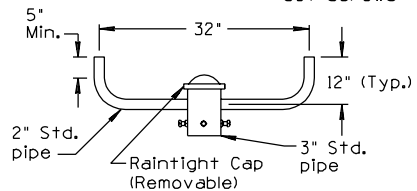
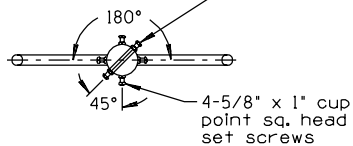

**DETAIL "C"  
TWIN LUMINAIRE  
BRACKET AND SET  
SCREW DETAIL**

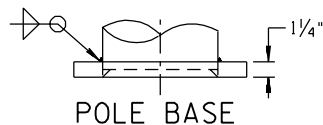

**POLE BASE**

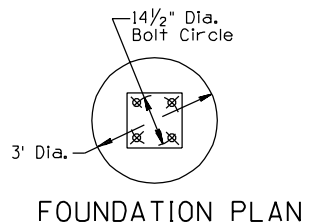

**FOUNDATION PLAN**

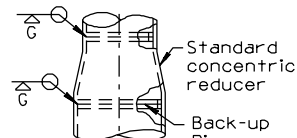

**DETAIL "F"**

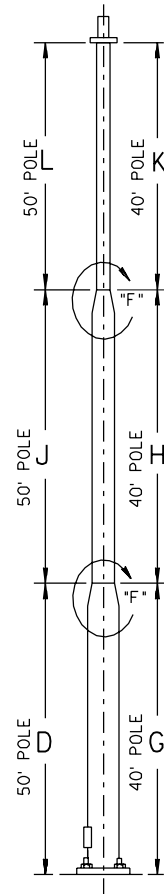
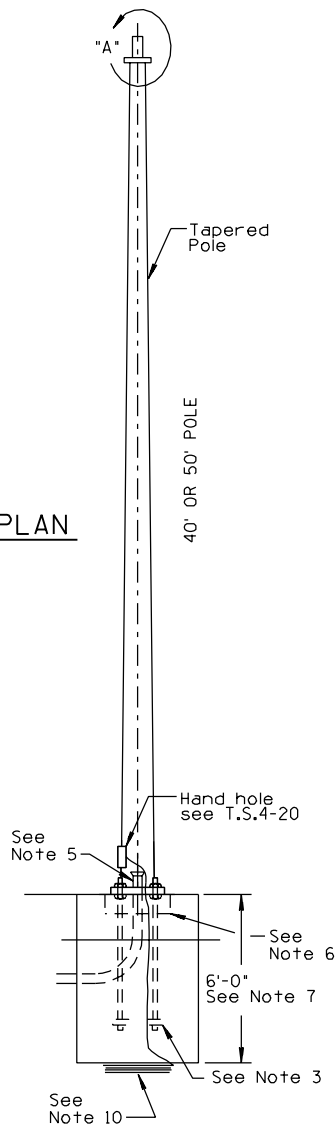

**PLAN SYMBOL**

**NOTES:**

1. All materials and construction shall conform to the requirements of the Specifications.
2. The type "T" pole shall be a 40' or 50' pole as per pole schedule on plans.
3. See T.S. 4-23 detail "B" for anchor bolt details. Each anchor bolt shall have four hex nuts and two flat washers, all to be furnished with pole.
4. Anchor bolts shall project 3" above the foundation.
5. Conduit shall project a minimum of 2" above the foundation. Maximum projection shall be 4".
6. Block out for leveling nuts. See specs. for grout requirements.
7. Unstable soil may require deeper foundation. See Specifications.
8. Pole shall be installed with hand hole on traffic side.
9. The pole, extension, and twin luminaire bracket shall be fully galvanized in accordance with ASTM-A-123.
10. A 25' coil of No. 4 AWG bare copper conductor shall be installed before the concrete is poured and connected to pole grounding screw in the hand hole.
11. The foundation hole shall be augered and class "S" (3000 psi) concrete poured against undisturbed compacted earth.
12. Pole shall comply with 1994 AASHTO loading requirements for Structural Supports for Highway Signs, Luminaires and Traffic Signals.
13. All dimensions are nominal.

DIMENSION	O.D. x LENGTH
D	8" x 20'-0"
G	6" x 15'-0"
H	5" x 15'-0"
J	6" x 18'-6"
K	4" x 10'-7.5"
L	4" x 12'-1.5"

DESIGN APPROVED

**SIGNATURE**

ARIZONA DEPT. OF TRANSPORTATION  
INTERMODAL TRANSPORTATION DIVISION  
TRAFFIC SIGNALS & LIGHTING  
STANDARD DRAWINGS

APPROVED FOR DISTRIBUTION

**ON FILE**

TYPE "T" POLE AND  
LUMINAIRE MOUNTING BRACKET

DRAWING NO.

T.S. 4-14