

[Click on MilePost numbers](#)
[to view Plans Index sheets](#)

ⓧ Mile Post Numbers

I - 10

Mile Post: 0 to 391

ADOT
Right Of Way Section

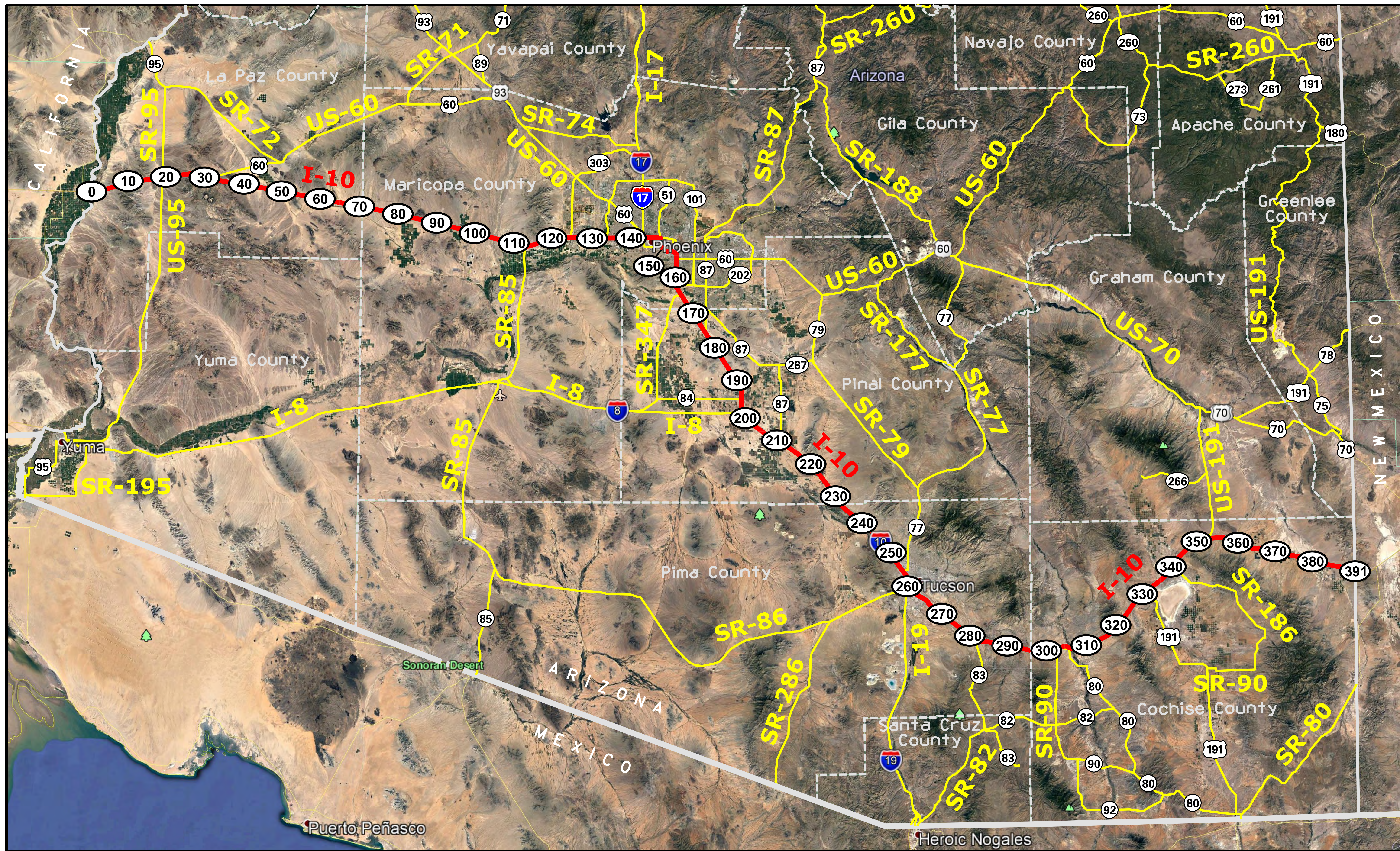

LA PAZ COUNTY

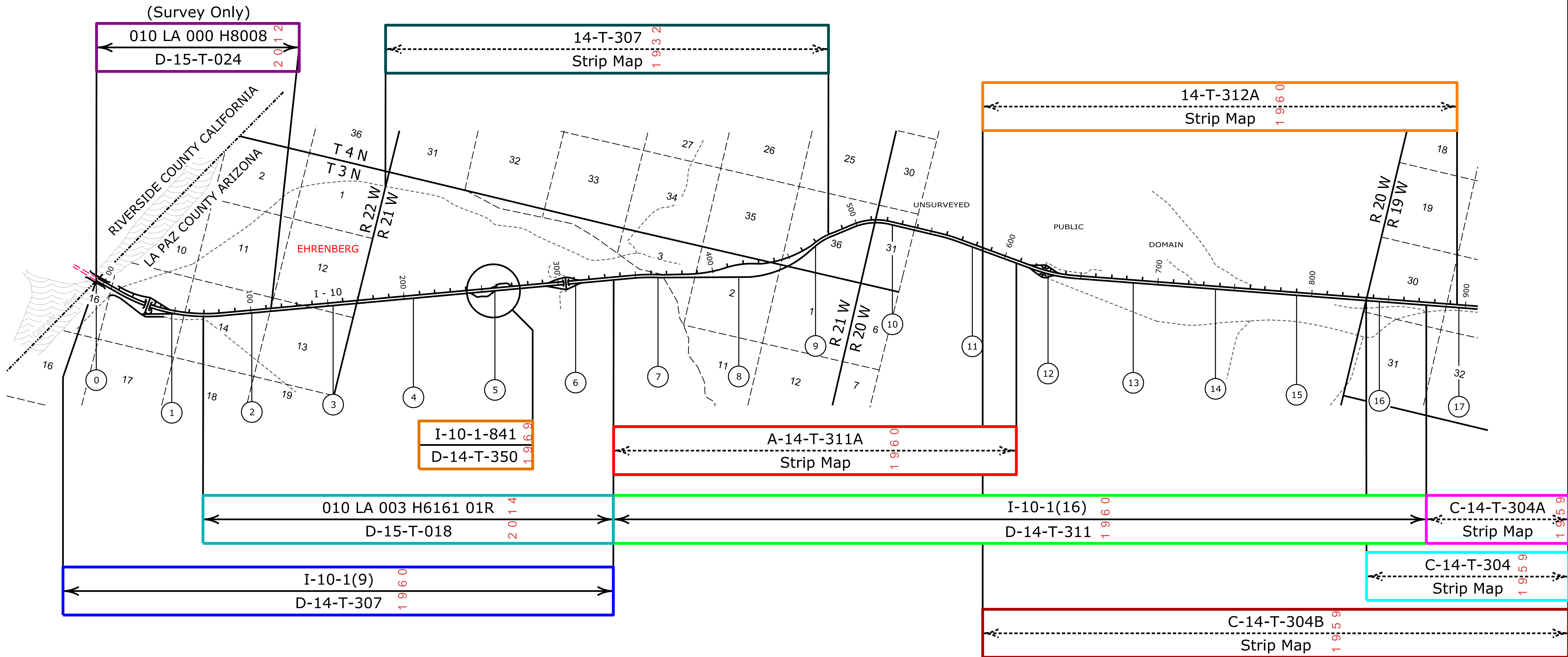
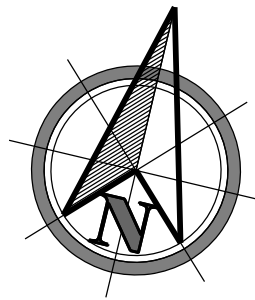

[Contact Us](#)

Click in colored box to view Plans/Maps

⊙ Mile Post Number



Right Of Way Index Map	ROUTE I - 10	MILEPOST 0.00 - 17.00
HIGHWAY NAME Ehrenberg - Phoenix Hwy		

LA PAZ COUNTY

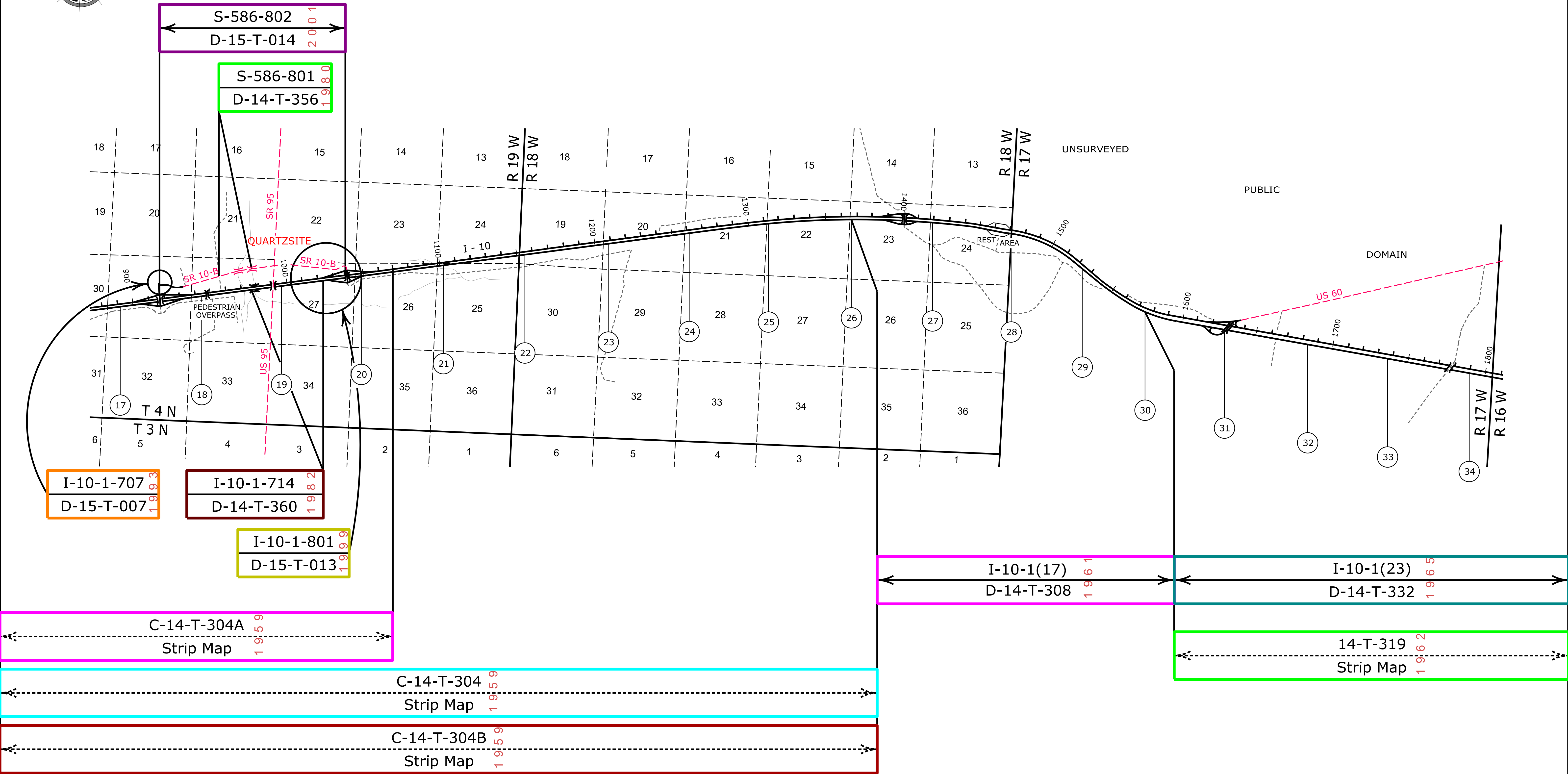
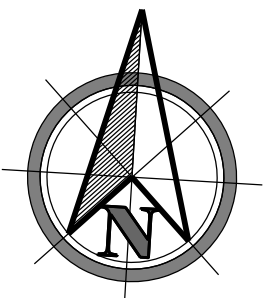

[Contact Us](#)

Click in colored box to view Plans/Maps
 (xx) Mile Post Number



Right Of Way Index Map	ROUTE I - 10	MILEPOST 17.00 - 34.00
HIGHWAY NAME Ehrenberg - Phoenix Hwy		

LA PAZ COUNTY

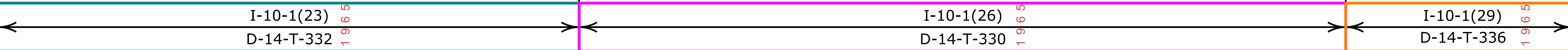
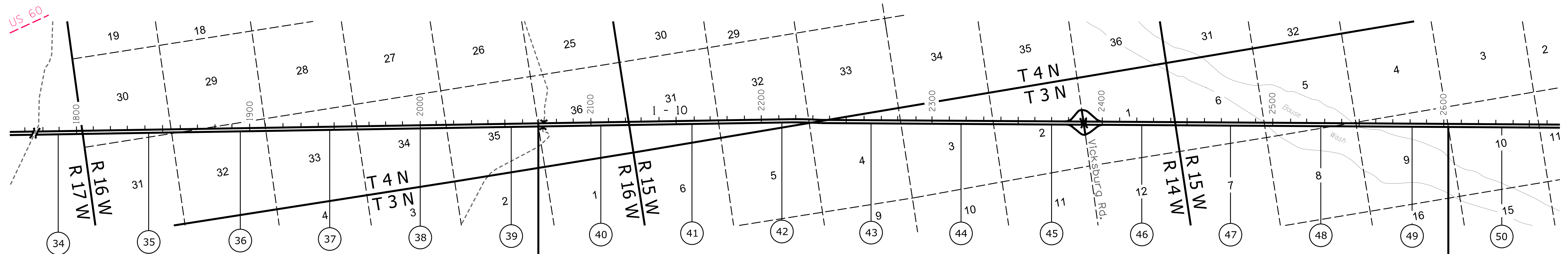
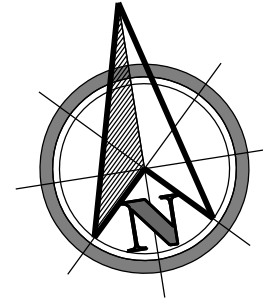

[Contact Us](#)

Click in colored box
to view Plans/Maps
(xx) Mile Post Number



Right Of Way Index Map	ROUTE I - 10	MILEPOST 34.00 - 50.00
HIGHWAY NAME Ehrenberg - Phoenix Hwy		

LA PAZ COUNTY

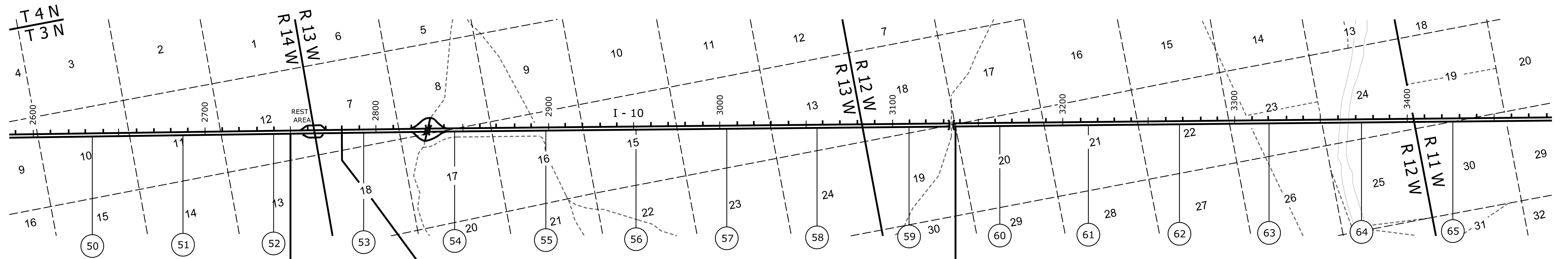
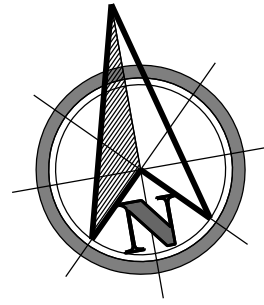

I-10-1-851
D-14-T-357

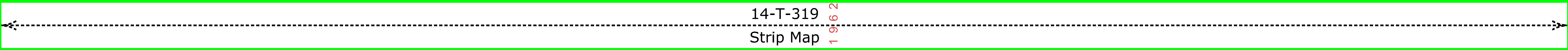

[Contact Us](#)

Click in colored box to view Plans/Maps
 (xx) Mile Post Number



Right Of Way Index Map	ROUTE I - 10	MILEPOST 50.00 - 65.00
HIGHWAY NAME Ehrenberg - Phoenix Hwy		

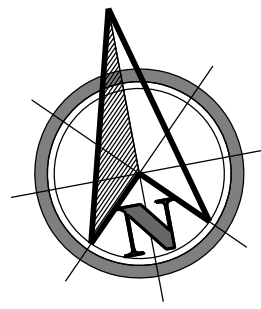

LA PAZ COUNTY

MARICOPA COUNTY

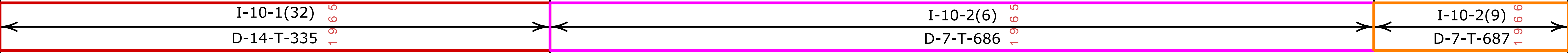
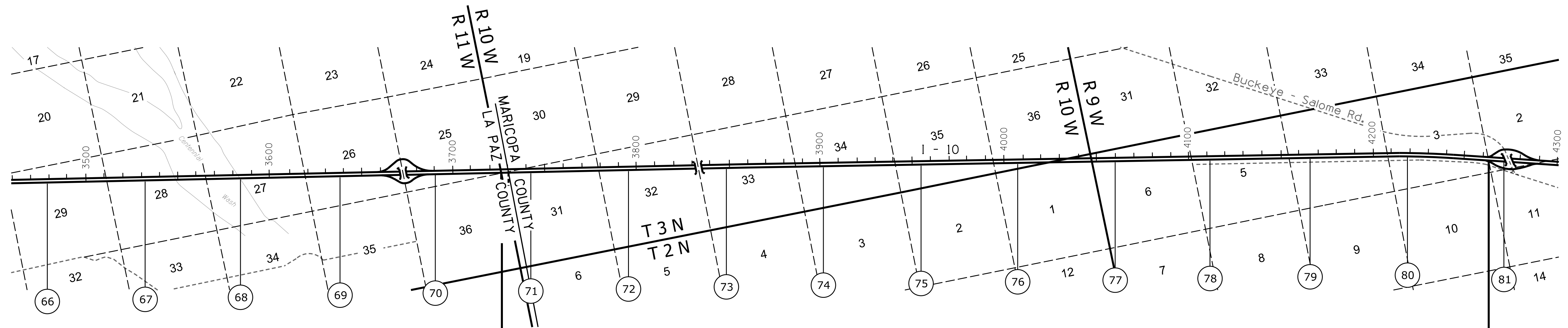

[Contact Us](#)

Click in colored box to view Plans/Maps

(xx) Mile Post Number



Right Of Way Index Map

ROUTE I - 10

MILEPOST 66.00 - 81.00

HIGHWAY NAME

Ehrenberg - Phoenix Hwy

5

MARICOPA COUNTY

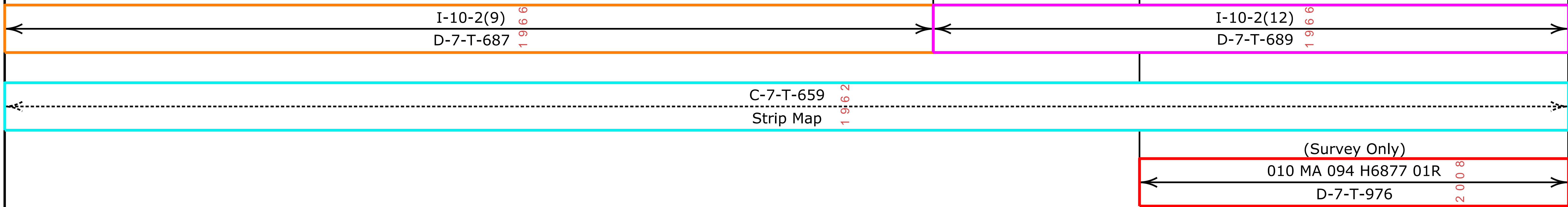
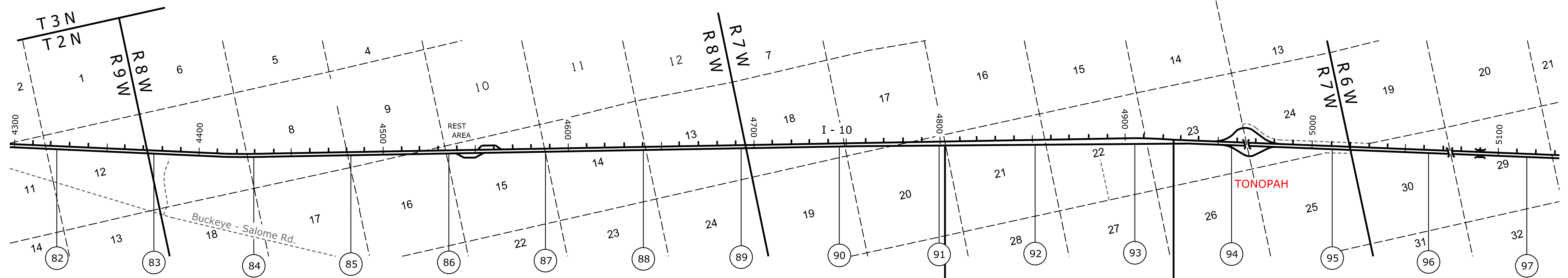
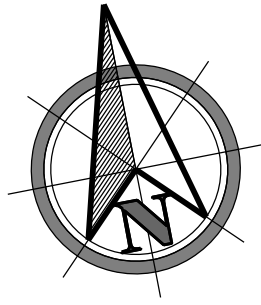

[Contact Us](#)

Click in colored box
to view Plans/Maps
⊗ Mile Post Number



Right Of Way Index Map	ROUTE I - 10	MILEPOST 82.00 - 97.00
HIGHWAY NAME Ehrenberg - Phoenix Hwy		

MARICOPA COUNTY

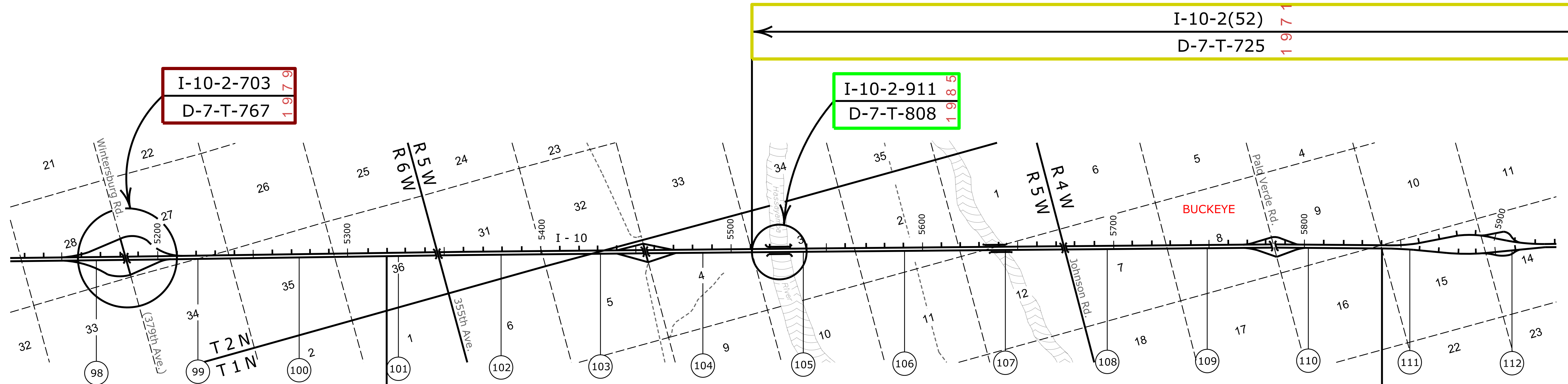
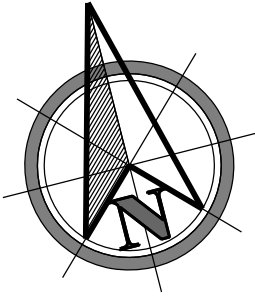

I-10-2-703
D-7-T-767
1 9 7 9

I-10-2-911
D-7-T-808
1 9 8 5

I-10-2(52) 1 9 7 1
D-7-T-725 1 9 6 1

I-10-2(12) 1 9 6 6
D-7-T-689

I-10-2(15) 1 9 6 7
D-7-T-697

C-7-T-659 1 9 6 2
Strip Map

I-10-2(27) 1 9 7 3
D-7-T-714

(Survey Only)
010 MA 094 H6877 01R 2 0 0 8
D-7-T-976

Contact Us

Click in colored box
to view Plans/Maps
ⓧ Mile Post Number



Right Of Way Index Map	ROUTE I - 10	MILEPOST 98.00 - 112.00
HIGHWAY NAME Ehrenberg - Phoenix Hwy		

7

MARICOPA COUNTY

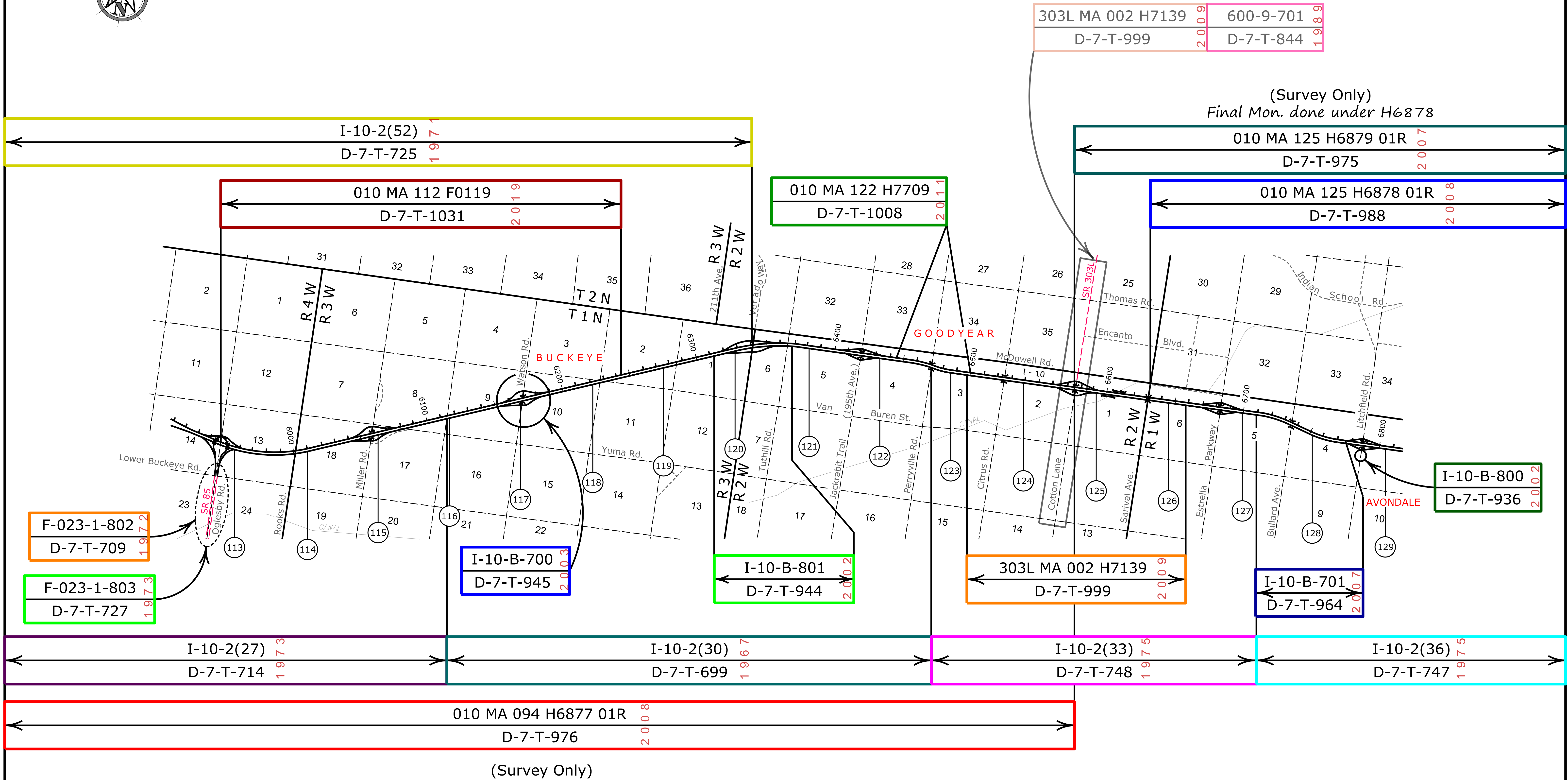
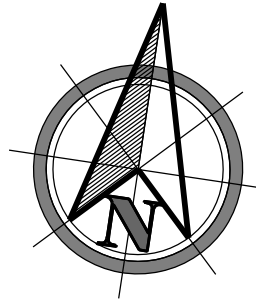

Contact Us

Click in colored box to view Plans/Maps
 (xx) Mile Post Number



Right Of Way Index Map	ROUTE I - 10	MILEPOST 113.00 - 129.00
Ehrenberg - Phoenix Hwy		

MARICOPA COUNTY

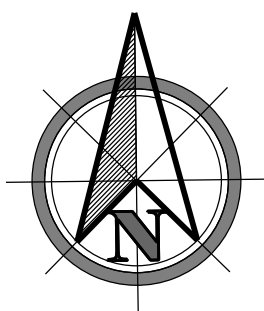

(Survey Only)
Final Mon. done under H6878

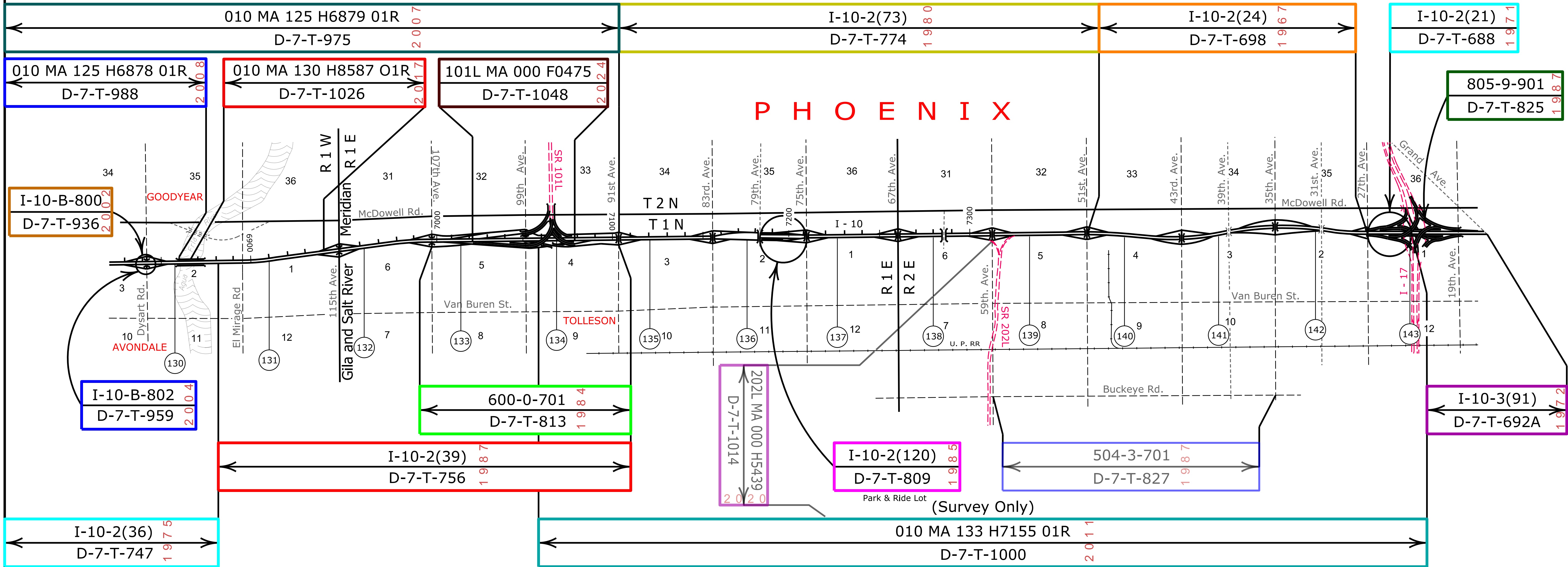

Contact Us

Click in colored box
to view Plans/Maps
⊗ Mile Post Number



Right Of Way Index Map	ROUTE I - 10	MILEPOST 130.00 - 143.00
HIGHWAY NAME Ehrenberg - Phoenix Hwy		

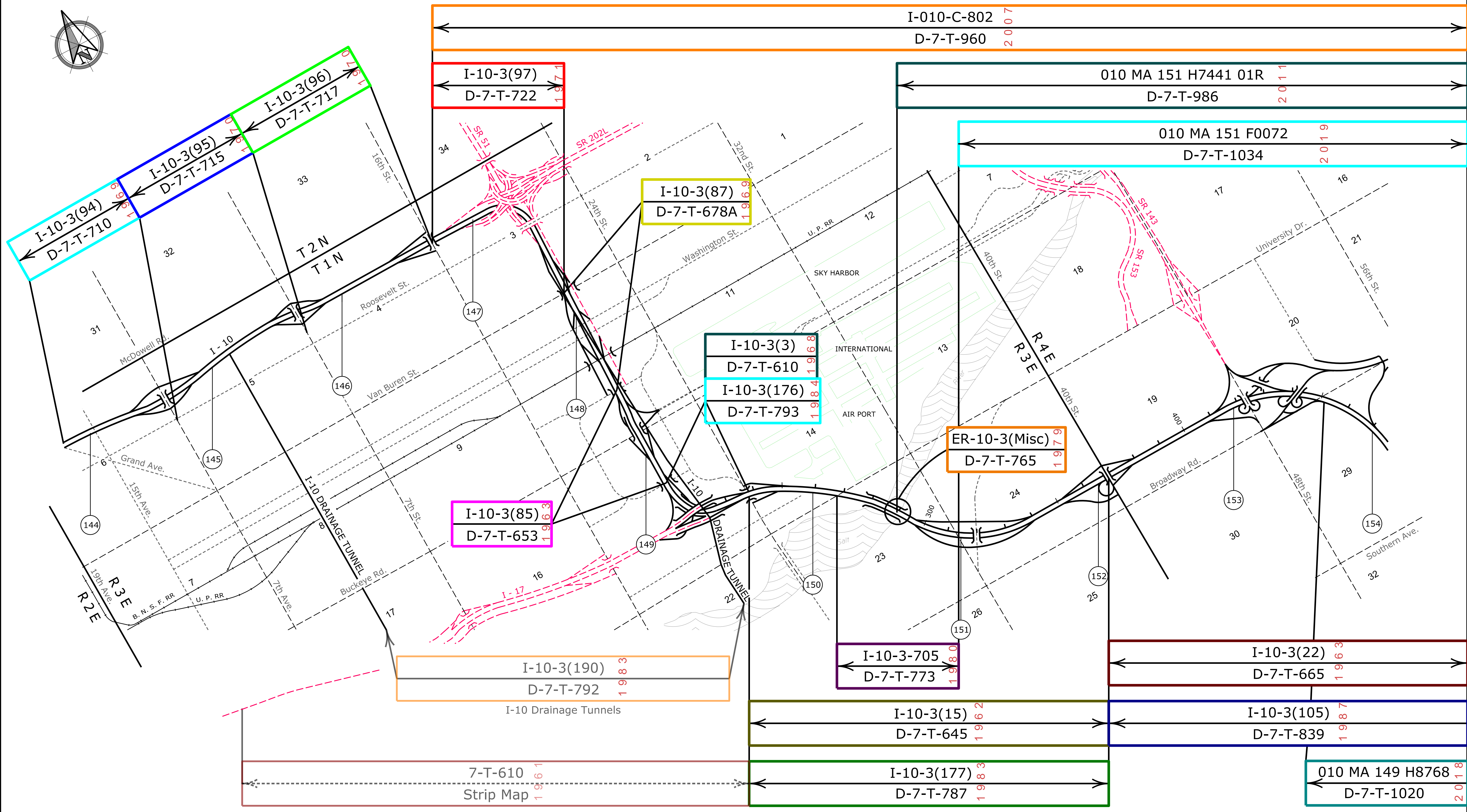
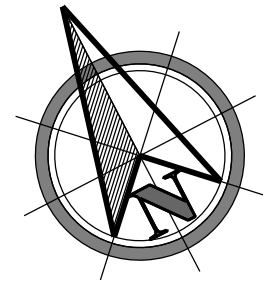

[Contact Us](#)

Click in colored box to view Plans/Maps
 (xx) Mile Post Number



Right Of Way Index Map	ROUTE I - 10	MILEPOST 144.00 - 154.00
HIGHWAY NAME		Phoenix - Casa Grande Hwy

10

MARICOPA COUNTY

(Survey Only)

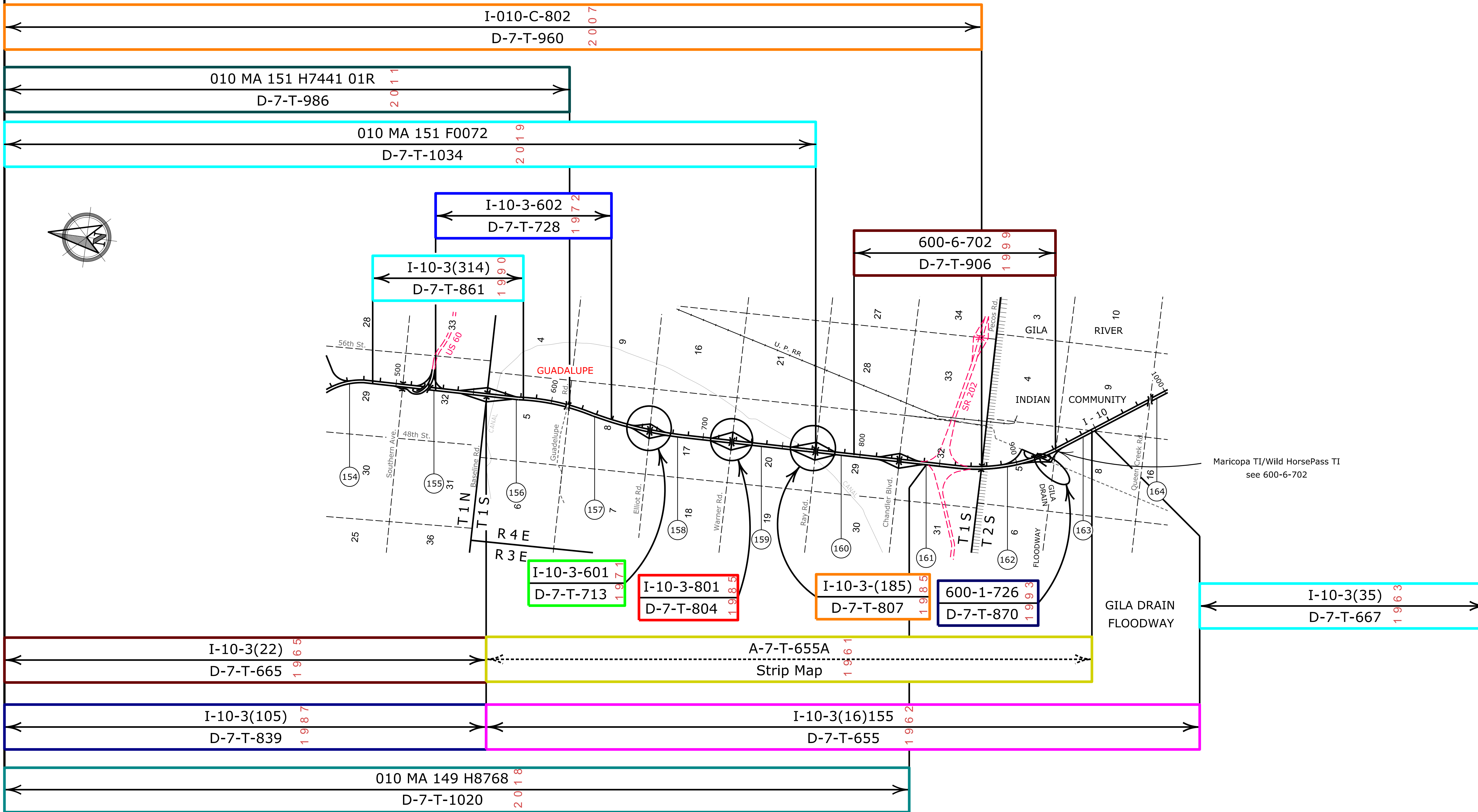

Contact Us

Click in colored box to view Plans/Maps
(xx) Mile Post Number



Right Of Way Index Map	ROUTE I - 10	MILEPOST 154.00 - 164.00
HIGHWAY NAME Phoenix - Casa Grande Hwy		

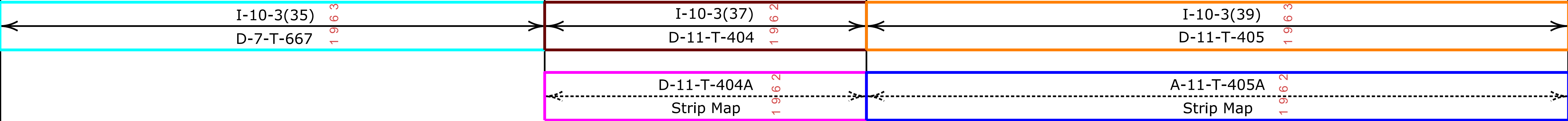
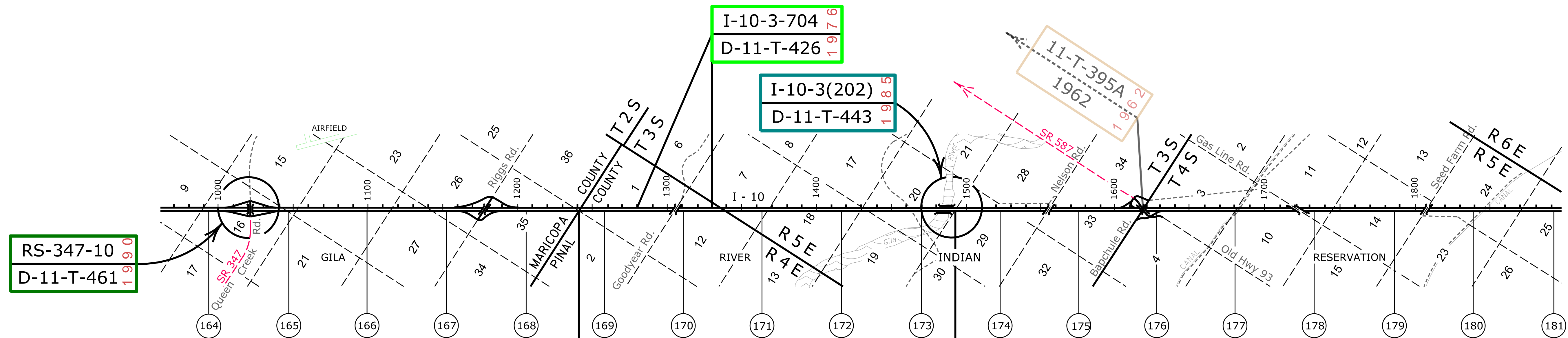
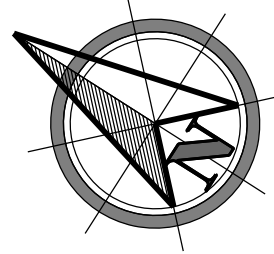

[Contact Us](#)

Click in colored box to view Plans/Maps
ⓧ Mile Post Number



Right Of Way Index Map	ROUTE I - 10	MILEPOST 164.00 - 181.00
HIGHWAY NAME Phoenix - Casa Grande Hwy		

PINAL COUNTY

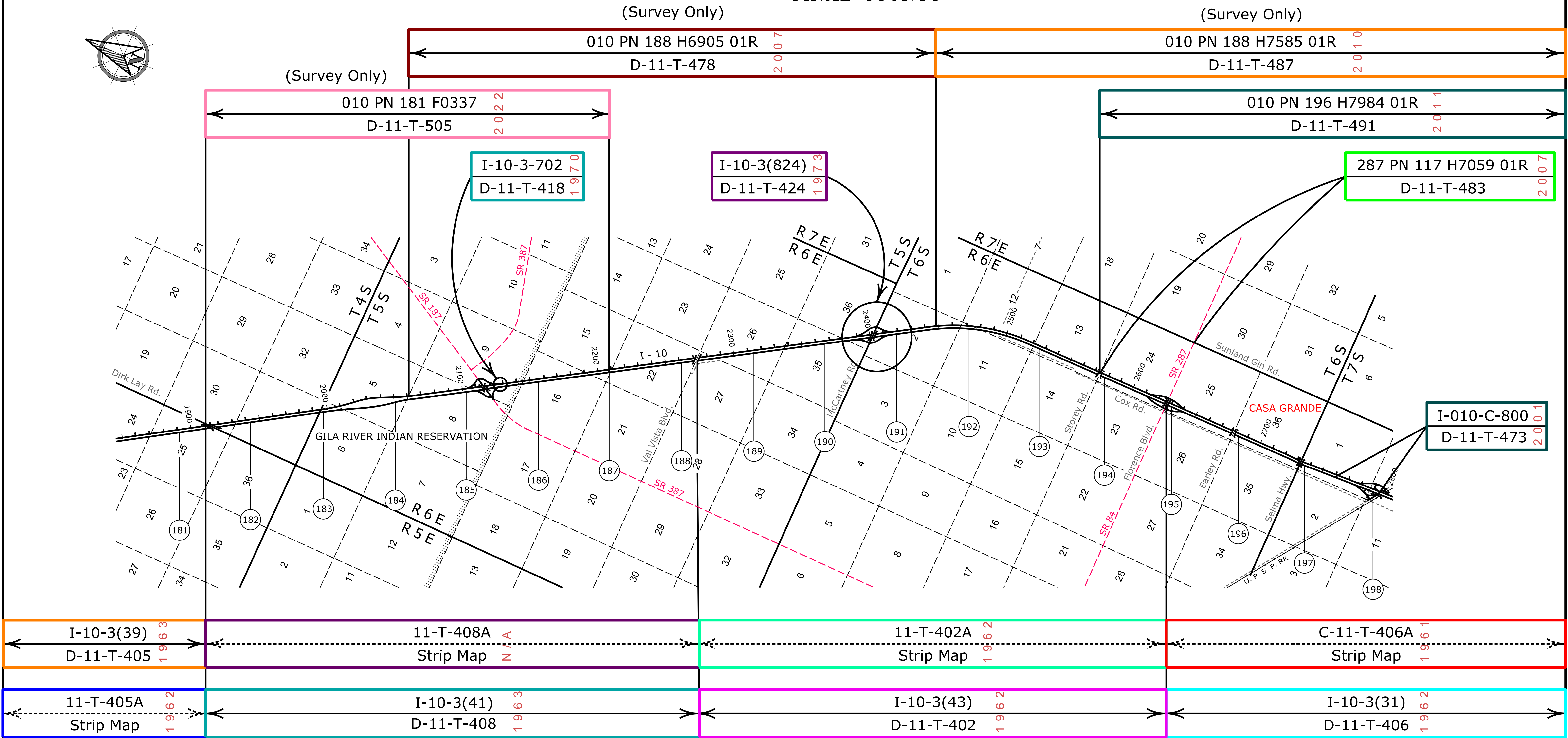
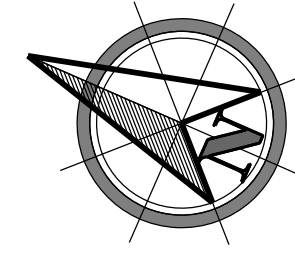

I-10-3(39) D-11-T-405 1 9 6 3	11-T-408A Strip Map N/A	11-T-402A Strip Map 1 9 6 2	C-11-T-406A Strip Map 1 9 6 1
11-T-405A Strip Map 1 9 6 2	I-10-3(41) D-11-T-408 1 9 6 3	I-10-3(43) D-11-T-402 1 9 6 2	I-10-3(31) D-11-T-406 1 9 6 2

[Contact Us](#)

Click in colored box
to view Plans/Maps
ⓧ Mile Post Number



Right Of Way Index Map	ROUTE I - 10	MILEPOST 181.00 - 198.00
HIGHWAY NAME Phoenix - Casa Grande Hwy		

PINAL COUNTY

(Survey Only)

(Survey Only)

010 PN 188 H7585 01R
D-11-T-487

010 PN 200 H7104 01R
D-11-T-484

010 PN 196 H7984
D-11-T-491

11-T-311
Strip Map

I-10-4(103)
D-11-T-451

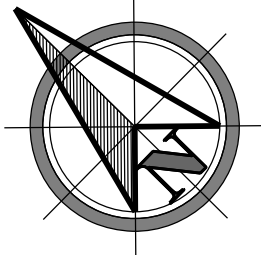

11-T-347
1956

I-10-4-801
D-11-T-457

I-10-4(45)
D-11-T-407

I-10-4(37)
D-11-T-376

C-11-T-406A
Strip Map

B-11-T-376A
Strip Map

I-10-3(31)
D-11-T-406

11-T-334
Strip Map

11-T-333
Strip Map

C-11-T-390
Strip Map

Proposed Line not Used

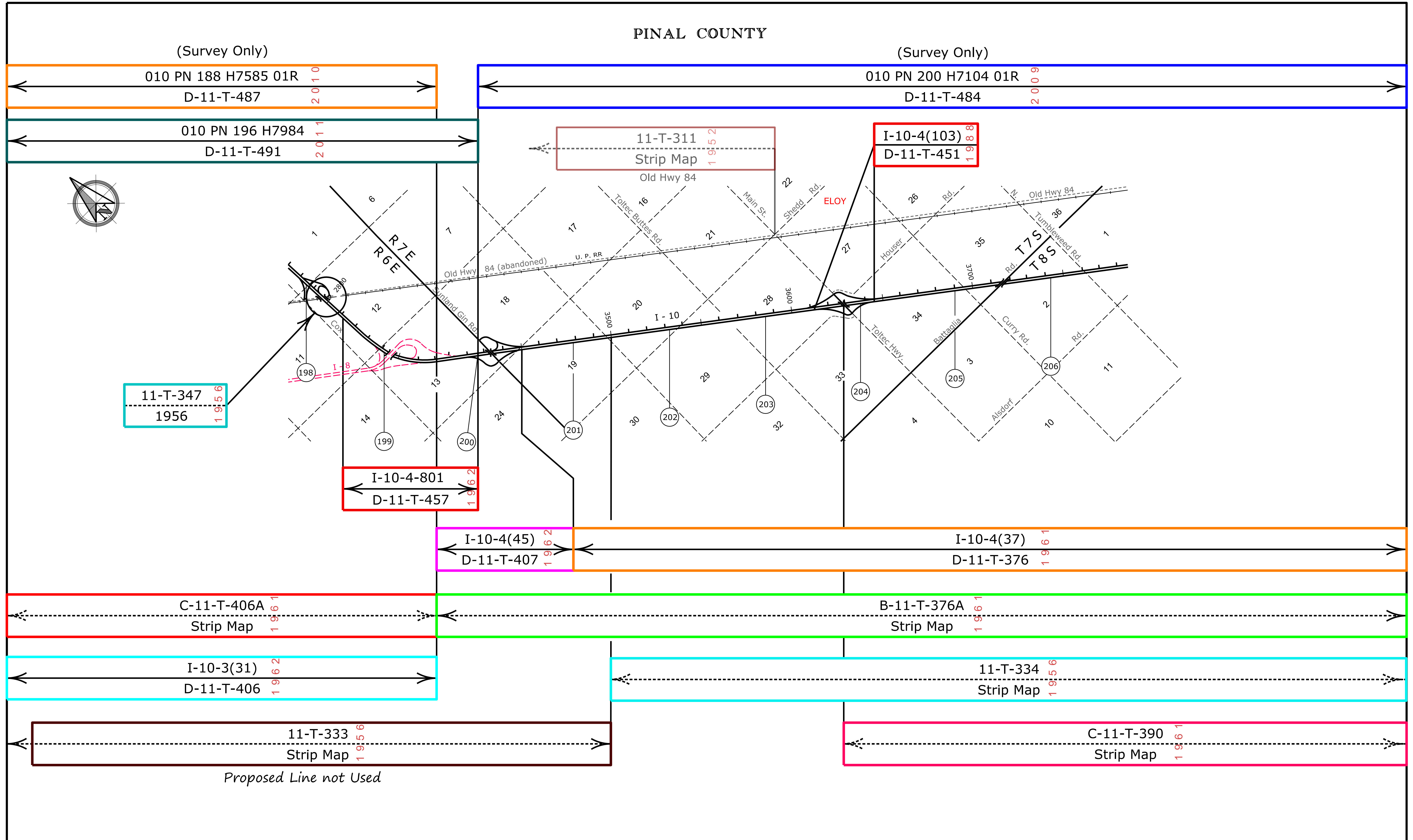

Contact Us

Click in colored box
to view Plans/Maps
ⓧ Mile Post Number



Right Of Way Index Map
HIGHWAY NAME
I - 10
MILEPOST
198.00 - 206.00
Casa Grande - Tucson Hwy

PINAL COUNTY

(Survey Only)

010 PN 200 H7104 01R
D-11-T-484 2 0 0 9

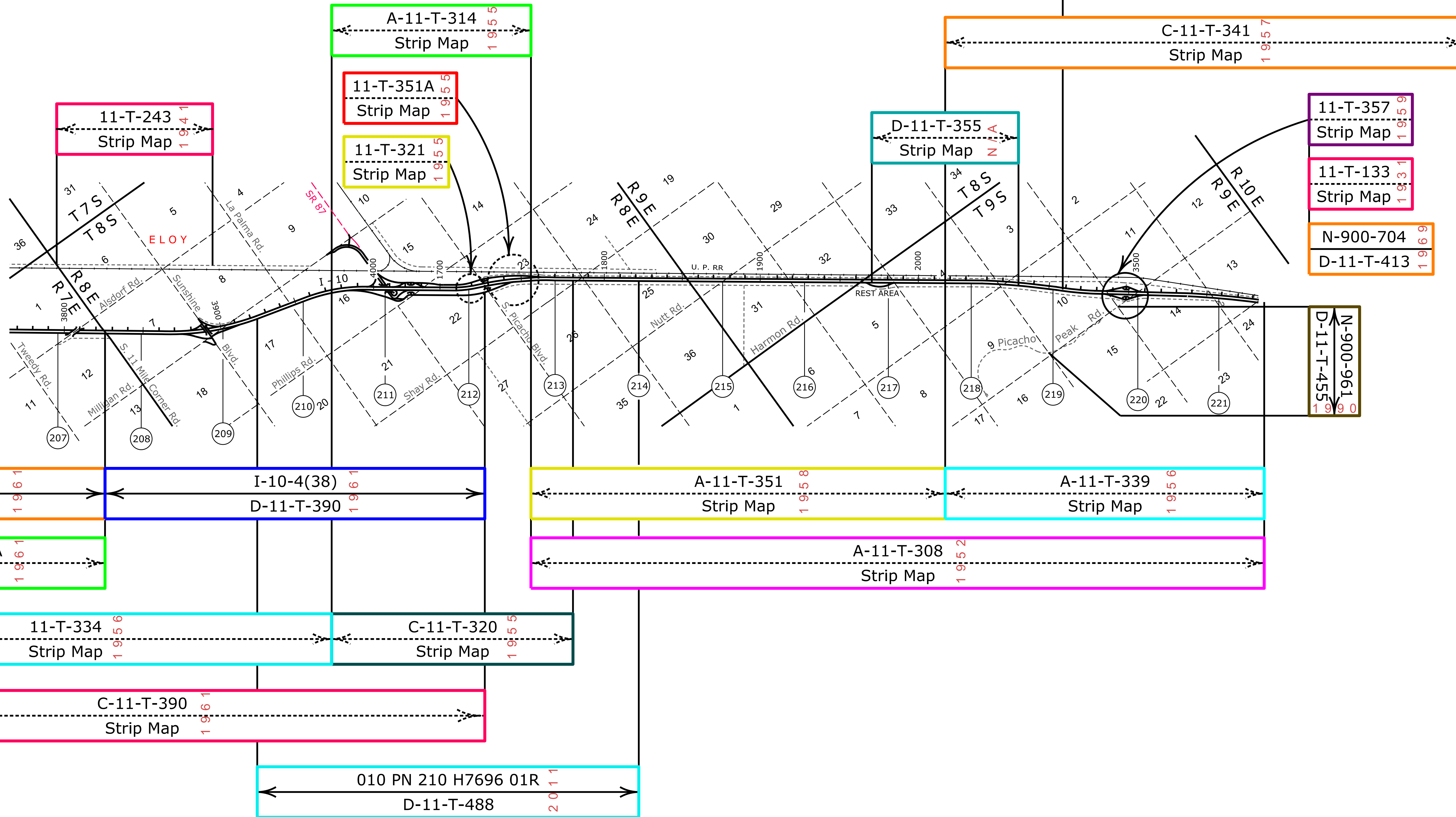
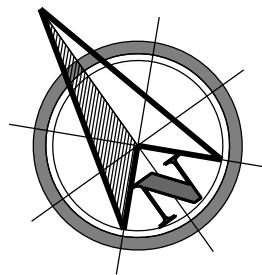

[Contact Us](#)

Click in colored box
to view Plans/Maps
ⓧ Mile Post Number



Right Of Way Index Map	ROUTE I - 10	MILEPOST 206.00 - 221.00
HIGHWAY NAME Casa Grande - Tucson Hwy		

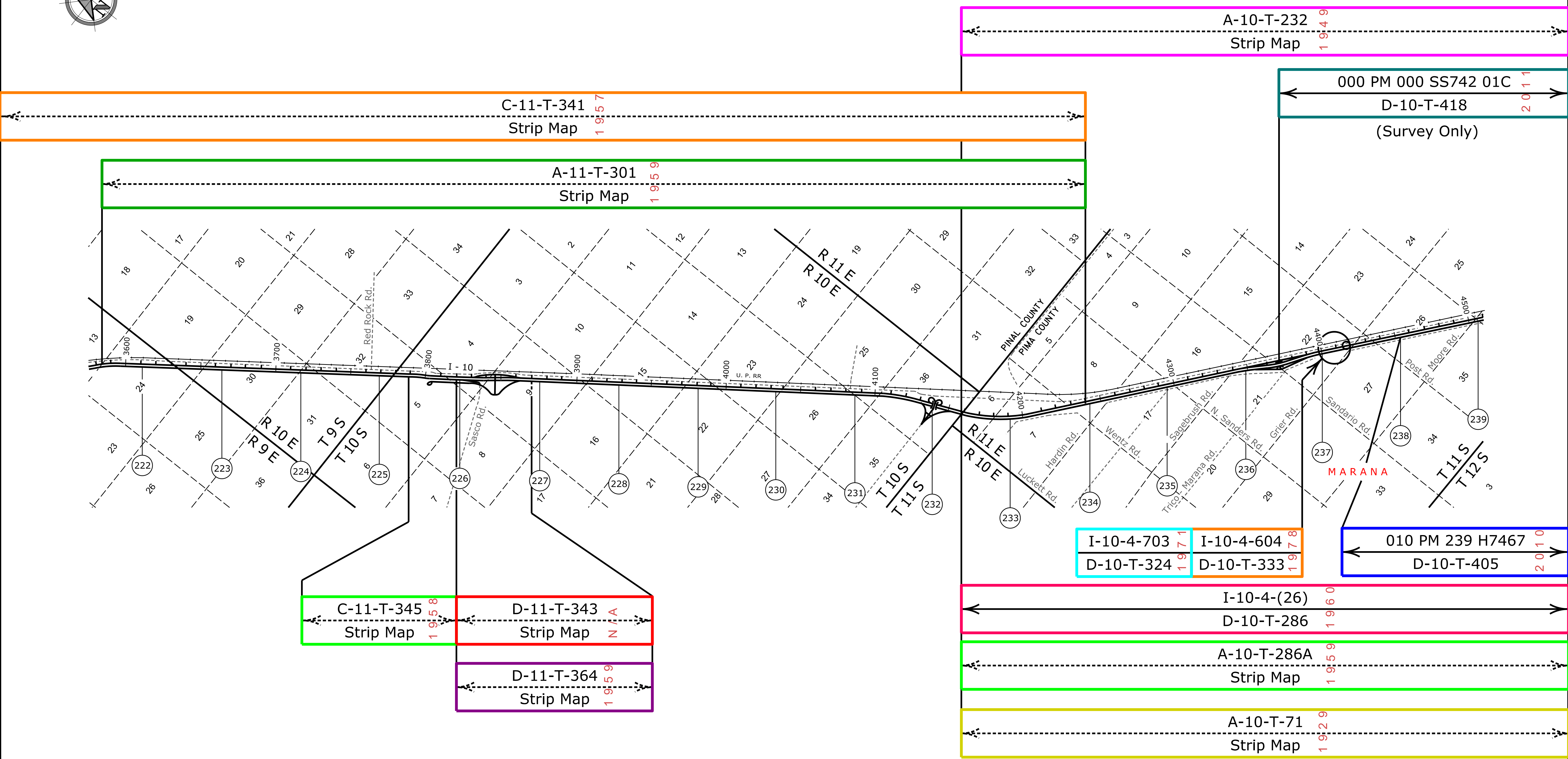
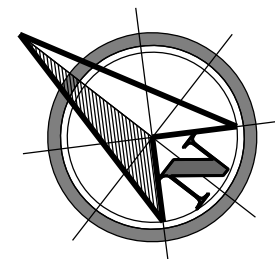

A-10-T-232
Strip Map 1 9 4 9

C-11-T-341
Strip Map 1 9 5 7

000 PM 000 SS742 01C
D-10-T-418
(Survey Only) 2 0 1 1

A-11-T-301
Strip Map 1 9 5 9

I-10-4-703
D-10-T-324 1 9 7 1

I-10-4-604
D-10-T-333 1 9 7 8

010 PM 239 H7467
D-10-T-405 2 0 1 0

C-11-T-345
Strip Map 1 9 5 8

D-11-T-343
Strip Map N/A

D-11-T-364
Strip Map 1 9 5 9

I-10-4-(26)
D-10-T-286 1 9 6 0

A-10-T-286A
Strip Map 1 9 5 9

A-10-T-71
Strip Map 1 9 2 9

Contact Us

Click in colored box
to view Plans/Maps
ⓧ Mile Post Number



Right Of Way Index Map	ROUTE I - 10	MILEPOST 222.00 - 239.00
HIGHWAY NAME Casa Grande - Tucson Hwy		

A-10-T-232 Strip Map 19149

000 PM 000 SS742 01C D-10-T-418 (Survey Only) 20111

010 PM 245 H5838 D-10-T-398 20115

(Survey Only) N-810-601 PM(4) D-10-T-430 19996

A-10-T-246 Strip Map 19553

E-10-T-267 Strip Map 19149

010 PM 248 H8479 D-10-T-423 20118

I-10-4(139) D-10-T-377 19994

A-10-T-265 Strip Map 1957

I-10-4(76) D-10-T-337 I-10-4(89) D-10-T-346 19841979

I-10-4(105) D-10-T-363 19988

010 PM 249 H7583 D-10-T-411 20222

010 PM 252 H6241 D-10-T-415 2009

I-10-4 D-10-T-368 19991

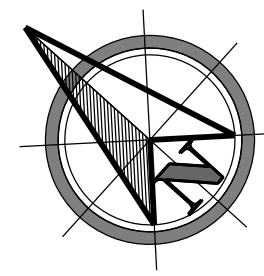

S-483-701 D-10-T-365

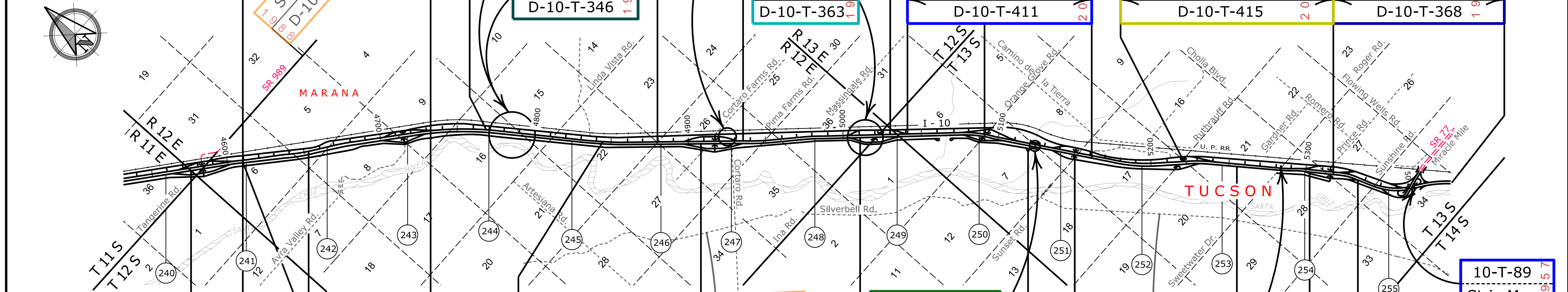

N-810-601 PM(2) 19179

010 PM 247 H7460 D-10-T-401 2008

10-T-212 Strip Map 19229

I-10-4(82) D-10-T-335 19179

10-T-216 Strip Map 19157

10-T-89 Strip Map 19157

010 PM 239 H7467 01R D-10-T-405 20110

010 PM 239 H7960 D-10-T-417 (Survey Only) 20110

I-10-4-805 D-10-T-382 19998

I-10-4(140) D-10-T-369 19993

I-10-4(26) D-10-T-286 1960

10-T-223 Strip Map 19146

A-10-T-286A Strip Map 1959

10-T-64 Strip Map 1929

A-10-T-71 Strip Map 1929

I-10-4(28) D-10-T-287 1961

I-10-4(29) D-10-T-288 1961

A-10-T-287A Strip Map 1961

010 PM 252 H8480 D-10-T-424 2018

Contact Us

Click in colored box to view Plans/Maps (xx) Mile Post Number



PIMA COUNTY

A-10-T-246
Strip Map 1953

E-10-T-267
Strip Map 1949

E-10-T-268
Strip Map 1951

A-10-T-265
Strip Map 1957

NH-10-4-141
D-10-T-375 1994

E-10-T-268A
Strip Map 1949

10-T-161	1940 (T14S R15E)	1940
10-T-151	1940 (T14S R15E)	1940

I-10-4-804
D-10-T-375 2002
Supplemental Survey

I-10-4(23)
D-10-T-296 1960

C-10-T-264
Strip Map 1957

NH-10-4-142
D-10-T-374 1994

NH-10-4(143)
D-10-T-378 1959

10-T-281
Strip Map 1959

10-T-255
Strip Map 1957

D-10-T-273
Strip Map 1958

I-10-4-940
D-10-T-352 1986

I-10-E-800
D-10-T-395 2004

I-10-4(140)
D-10-T-369 1993

F-031-1-715
D-10-T-361 1987

I-10-4-704
D-10-T-344 1983

I-10-4(144)
D-10-T-370 1993

IR-10-4(116)
D-10-T-368B 1992

NH-10-4(143)
D-10-T-368A 1989

10-T-64
Strip Map 1929

C-10-T-278
Strip Map 1959

D-10-T-285
Strip Map 1959

I-10-5(64)
D-10-T-362 1989

USG-412(2)
D-10-T-304 1961

I-10-4-808
D-10-T-383 1999

019 PM 057 H5105 01R
D-10-T-419 2011

(Survey Only)

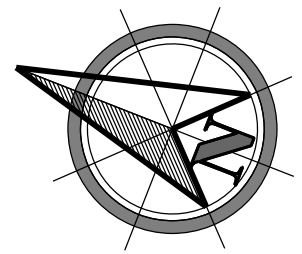

Contact Us

Click in colored box
to view Plans/Maps
ⓧ Mile Post Number



Right Of Way Index Map ROUTE I - 10 MILEPOST 256.00 - 261.00
HIGHWAY NAME Tucson - Benson Hwy

PIMA COUNTY

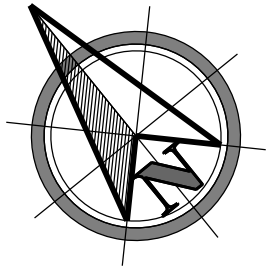

(Survey Only)

I-010-E-701
D-10-T-394 2006

010 PM 263 H7854
D-10-T-412 2011

010 PM 264 H7458 01R
D-10-T-406 2011

010 PM 267 H7505 01R
D-10-T-421 2010

M-951-1
D-10-T-366 1990

CJIF-000-2(33)
D-10-T-339 1980

I-10-5(4)
D-10-T-290 1963

010 PM 268 H7605
D-10-T-408 2010

010 PM 269 H7461
D-10-T-402 2009

I-10-5(64)
D-10-T-362 1989

A-10-T-259
Strip Map 1957

10-T-230
Strip Map 1948

A-10-T-245
Strip Map 1952

019 PM 057 H5105
D-10-T-419 2011

(Survey Only)

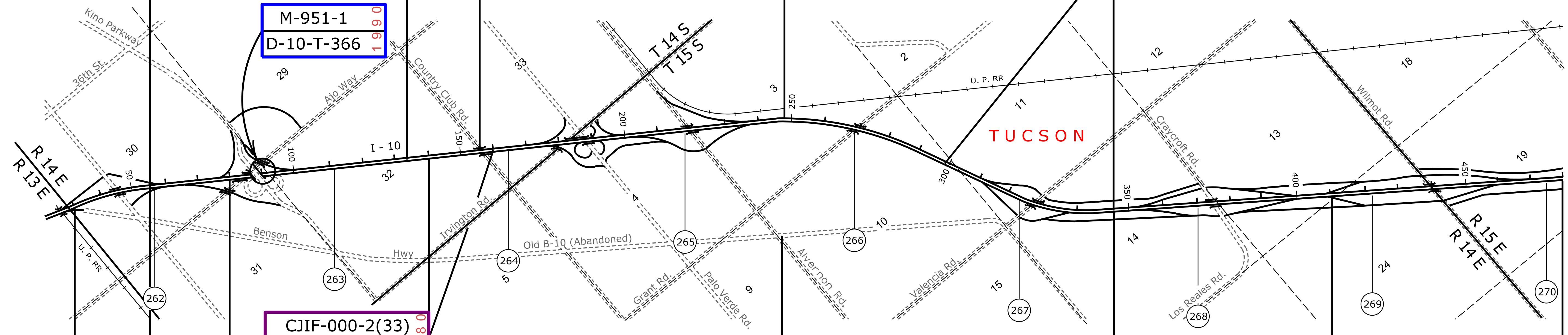

[Contact Us](#)

Click in colored box
to view Plans/Maps
ⓧ Mile Post Number



Right Of Way Index Map	ROUTE I - 10	MILEPOST 261.00 - 270.00
Tucson - Benson Hwy		

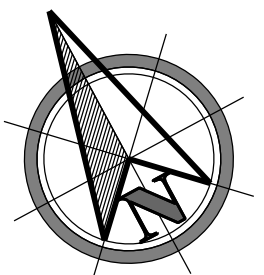

PIMA COUNTY

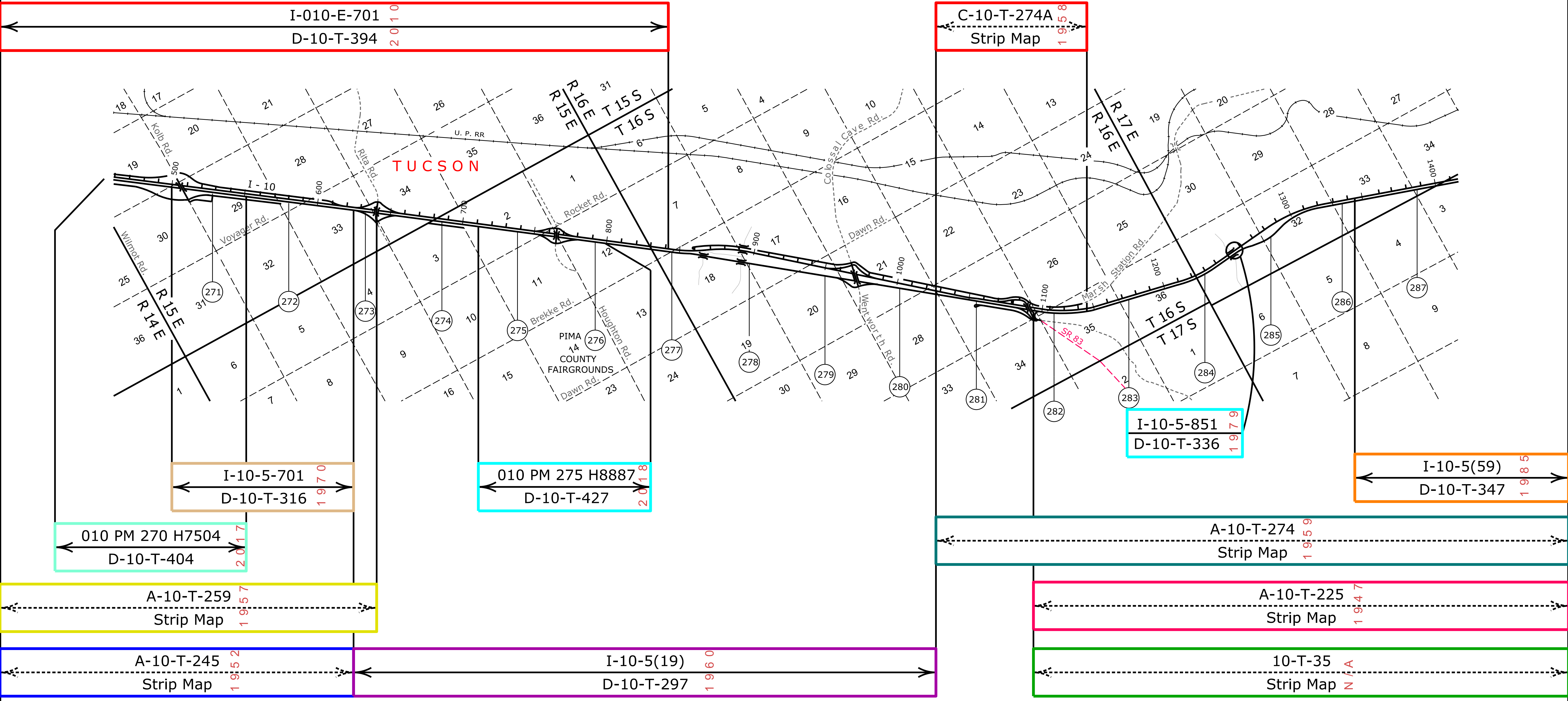

[Contact Us](#)

Click in colored box to view Plans/Maps
Ⓧ Mile Post Number



Right Of Way Index Map	ROUTE I - 10	MILEPOST 271.00 - 287.00
Tucson - Benson Hwy		

20

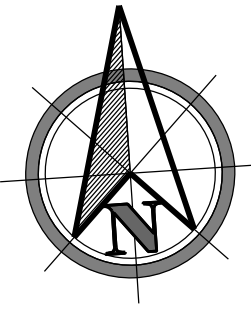

I-10-5-601
D-10-T-328 1976

C-10-T-274A
Strip Map 1958

2-T-21
Strip Map N/A

2-T-385
Strip Map 1959

I-10-5(59)
D-10-T-347 1985

I-10-5(38)
D-10-T-303A 1968

I-10-5-851
D-10-T-336 1979

SM C-10-T-96
1933 N/A

I-10-5-602
D-2-T-460 1981

R-AD-16(1)
D-2-T-367A 1960

I-10-5-702
D-2-T-461 1983

2-T-408
Strip Map 1961

A-10-T-274
Strip Map 1959

C-10-T-303A
Strip Map 1960

A-2-T-367
Strip Map 1957

I-10-5(21)
D-10-T-303 1961

C-2-T-299
Strip Map 1941

I-10-5(23)
D-2-T-419 1965

A-10-T-225
Strip Map 1947

010 CH 298 H6504
D-2-T-483 2010

10-T-35
Strip Map N/A

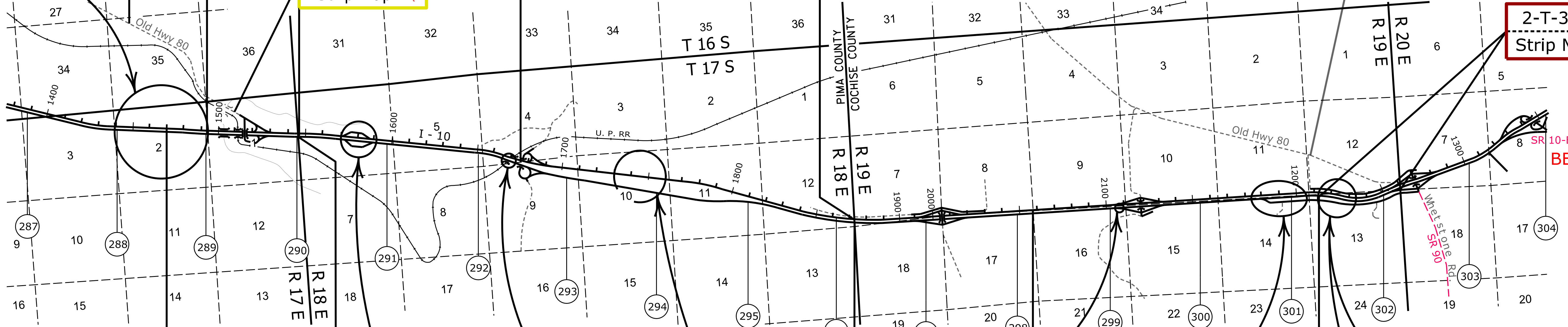

Contact Us

Click in colored box to view Plans/Maps
ⓧ Mile Post Number



Right Of Way Index Map	ROUTE I - 10	MILEPOST 287.00 - 304.00
Tucson - Benson Hwy		

COCHISE COUNTY

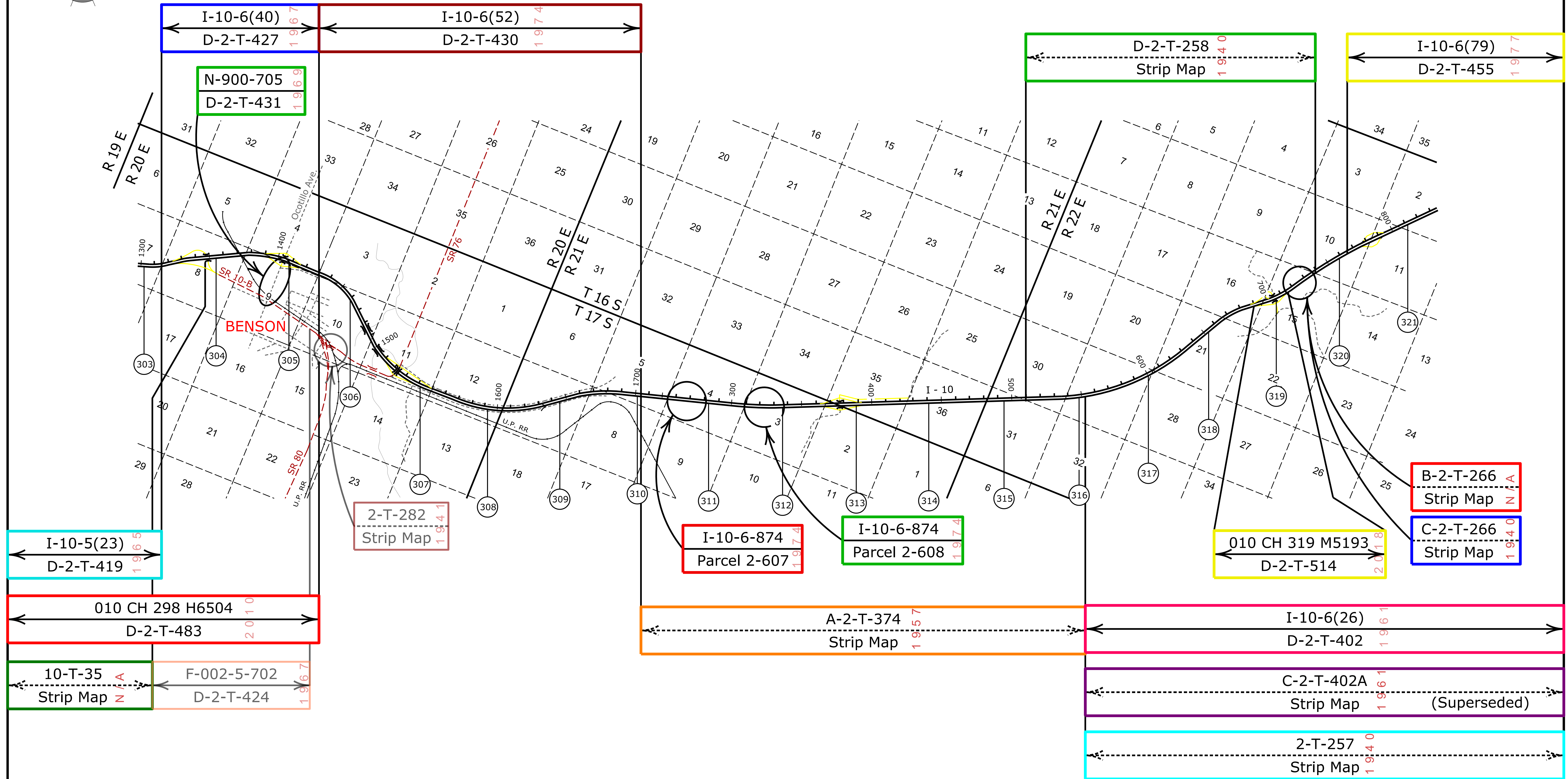
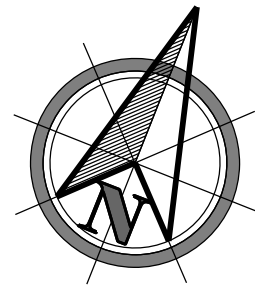

[Contact Us](#)

Click in colored box
to view Plans/Maps
Ⓧ Mile Post Number



Right Of Way Index Map	ROUTE I - 10	MILEPOST 303.00 - 321.00
HIGHWAY NAME Benson - Steins Pass Hwy		

22

COCHISE COUNTY

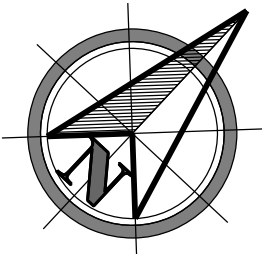

I-10-6(79)
D-2-T-455
1 9 7 7

I-10-6(23)
D-2-T-390
1 9 6 1

2-T-390C
Strip Map
1 9 6 1

2-T-390A
Strip Map
1 9 6 1

010 CH 331 H8534
D-2-T-510
2 0 1 6

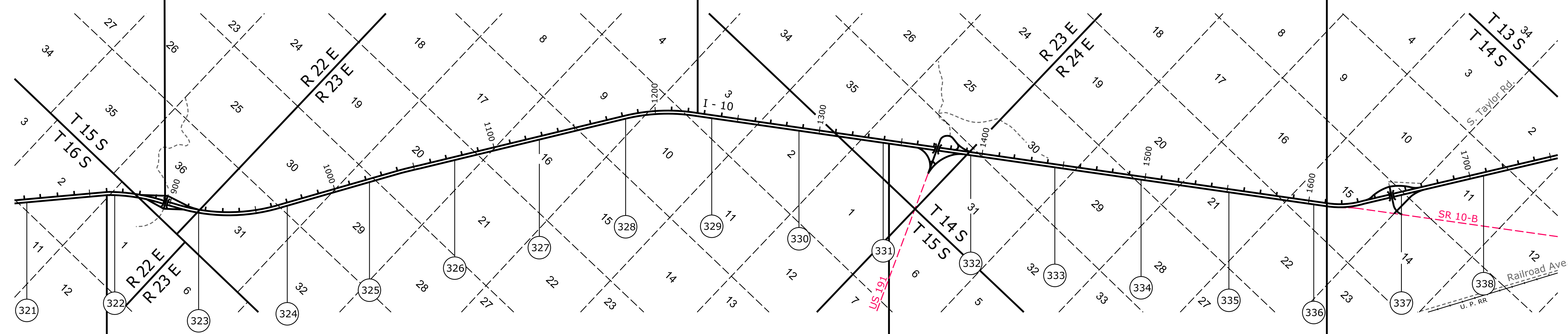

A-2-T-366
Strip Map
1 9 5 7

A-2-T-372
Strip Map
1 9 5 7

D-2-T-390
Strip Map
1 9 5 9

I-10-6(26)
D-2-T-402
1 9 6 1

C-2-T-402A
Strip Map
1 9 6 1
(Superseded)

2-T-257
Strip Map
1 9 4 0

[Contact Us](#)

Click in colored box
to view Plans/Maps
Ⓧ Mile Post Number



Right Of Way Index Map	ROUTE I - 10	MILEPOST 321.00 - 338.00
HIGHWAY NAME Benson - Steins Pass Hwy		

23

COCHISE COUNTY

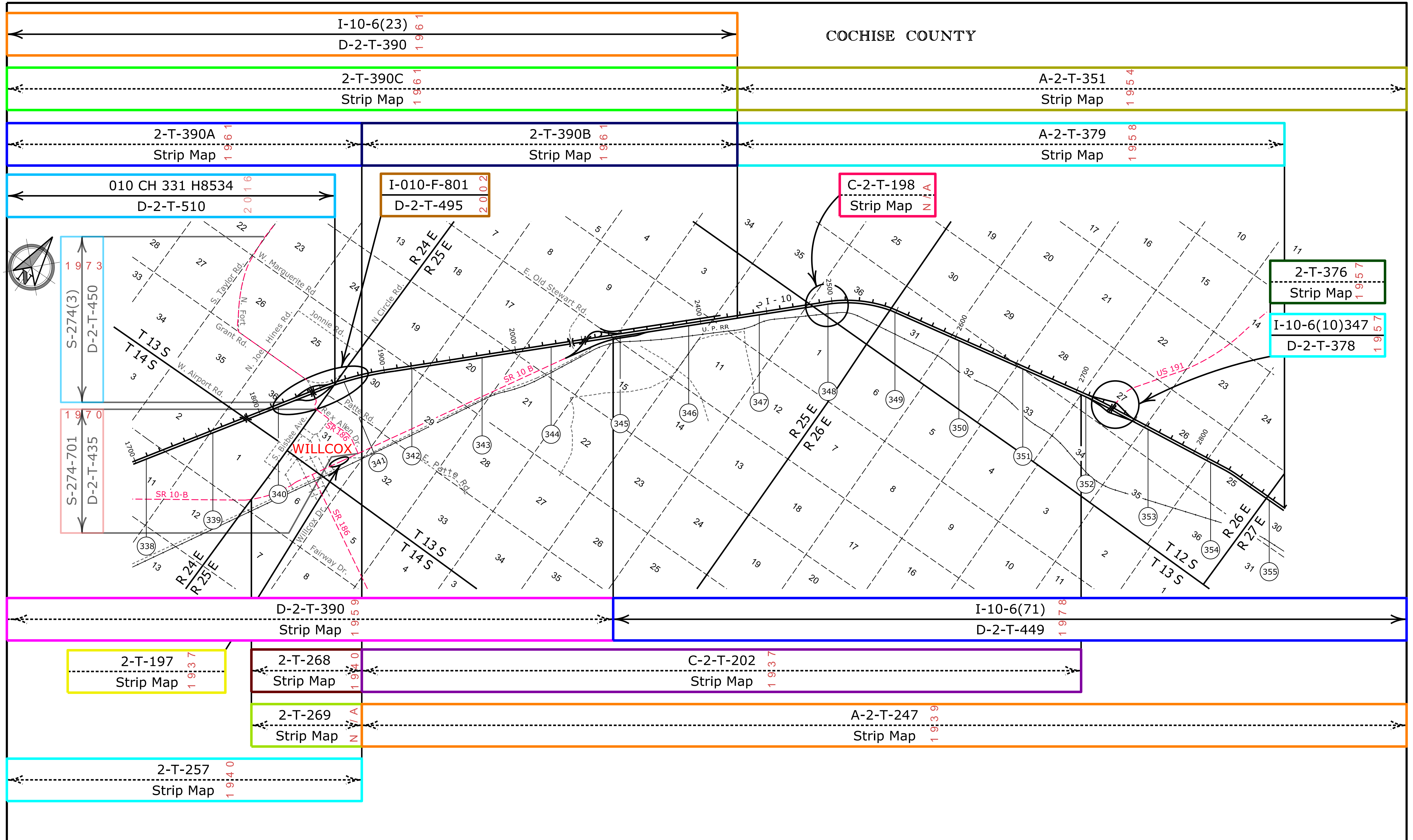

Contact Us

Click in colored box to view Plans/Maps
⊗ Mile Post Number



Right Of Way Index Map	ROUTE I - 10	MILEPOST 338.00 - 355.00
HIGHWAY NAME Benson - Steins Pass Hwy		

COCHISE COUNTY

A-2-T-351
Strip Map 1954

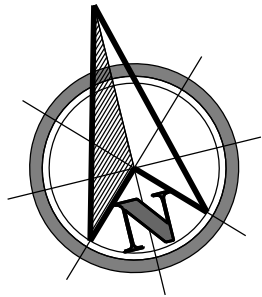

I-10-6(15) 1957
D-2-T-382 1957

I-10-6(37) 1962
D-2-T-411 1962

I-10-6(17) 1960
D-2-T-394 1960

I-002-5
D-2-T-376 1958

I-10-6-920
D-2-T-464 1985

C-2-T-411A
Strip Map 1962

2-T-253
Strip Map 1939

2-T-394A
Strip Map 1960

I-10-6(71) 1978
D-2-T-449 1978

A-2-T-264
Strip Map 1940

A-2-T-247
Strip Map 1939

2-T-234
Strip Map 1939

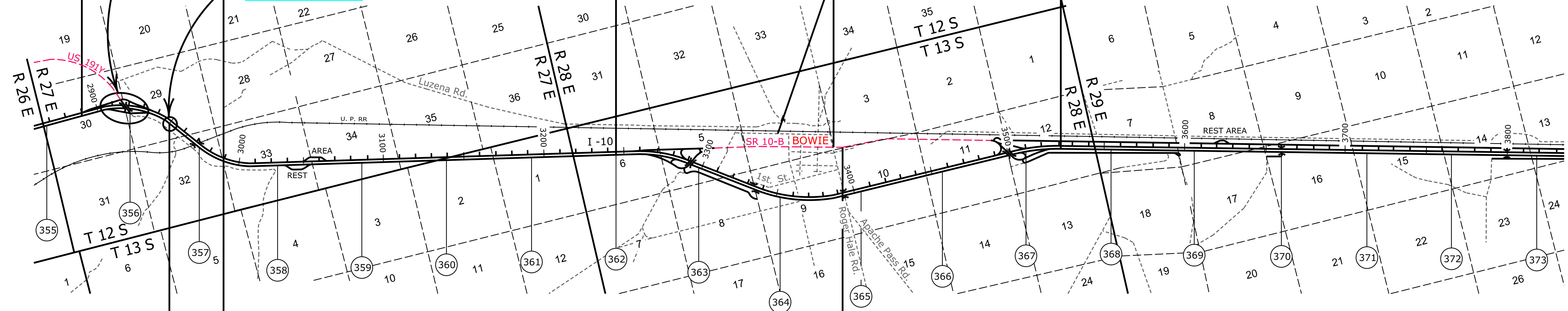

Contact Us

Click in colored box
to view Plans/Maps
Ⓧ Mile Post Number



Right Of Way Index Map	ROUTE I - 10	MILEPOST 355.00 - 373.00
HIGHWAY NAME Benson - Steins Pass Hwy		

25

COCHISE COUNTY

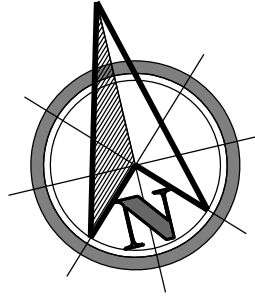

I-10-6(17)
D-2-T-394 1 9 6 0

2-T-394A
Strip Map 1 9 6 0

I-10-6-887
D-2-T-459 1 9 8 1

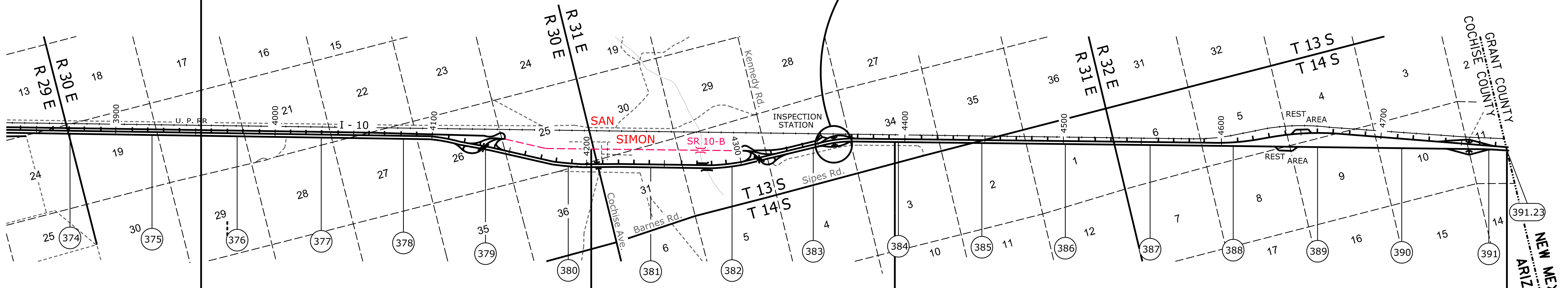

I-10-6(34)
D-2-T-406 1 9 6 2

I-10-6(19)
D-2-T-395 1 9 6 0

C-2-T-406
Strip Map 1 9 6 1

2-T-234
Strip Map 1 9 3 9

B-2-T-200
Strip Map 1 9 3 7 (Old 86)

Contact Us

Click in colored box to view Plans/Maps
ⓧ Mile Post Number



Right Of Way Index Map	ROUTE I - 10	MILEPOST 374.00 - 391.23
HIGHWAY NAME Benson - Steins Pass Hwy		

26