



RHODES – ITMS – MILOS: Ramp Metering System Test

Final Report 481

Prepared by:

Frank W. Ciarallo
Pitu B. Mirchandani
ATLAS Research Center
Systems & Industrial Engineering Department
The University of Arizona
Tucson, Arizona 85721

April 2002

Prepared for:

Arizona Department of Transportation
206 S. 17th Avenue
Phoenix Arizona 85007
in cooperation with
U.S. Department of Transportation
Federal Highway Administration

DISCLAIMER

The contents of this report reflect the views of the authors who are responsible for the facts and the accuracy of the data presented herein. The contents do not necessarily reflect the official views or policies of the Arizona Department of Transportation or the Federal Highway Administration. This report does not constitute a standard, specification, or regulation. Trade or manufacturers' names which may appear herein are cited only because they are considered essential to the objectives of the report. The U.S. Government and the State of Arizona do not endorse products or manufacturers.

Technical Report Documentation Page

1. Report No. FHWA-AZ02-481		2. Government Accession No.		3. Recipient's Catalog No.	
4. Title and Subtitle RHODES-ITMS-MILOS : Ramp Metering System Test		5. Report Date April 2002		6. Performing Organization Code	
		8. Performing Organization Report No.			
7. Author Frank W. Ciarallo & Pitu Mirchandani		9. Performing Organization Name and Address: Systems & Industrial Engineering Department The University of Arizona Tucson, Arizona 85721		10. Work Unit No.	
				11. Contract or Grant No. JPA 98-55 / SPR-PL-1(55)-481	
12. Sponsoring Agency Name And Address: Arizona Department Of Transportation 206 S. 17th Avenue Phoenix, Arizona 85007		13. Type of Report & Period Covered Final Report 7/98-09/01		14. Sponsoring Agency Code	
15. Supplementary Notes Prepared in cooperation with the U.S. Department of Transportation, Federal Highway Administration					
16. Abstract <p>The RHODES-Integrated Traffic Management System Program addresses the design and development of a real-time traffic adaptive control system for an integrated system of freeways and arterial roads. The goals of this project were to test coordinated, adaptive ramp metering using the Multi-Objective, Integrated, Large-Scale, and Optimized System (MILOS) software on a major urban freeway. A 7-mile eastbound segment of I-10 in Phoenix, just west of the I-10/I-17 interchange, was chosen as the study area because of the availability of data, and because of recurring congestion.</p> <p>The field test was to be accomplished in three phases: (i) testing the hierarchical MILOS control software via simulation, (ii) development of interfaces necessary to use MILOS in the field, and (iii) testing the effectiveness of MILOS in real time.</p> <p>The project accomplished the first of these objectives, developing a simulation model of the I-10 freeway and showing through experiments that coordinated adaptive ramp metering is more effective than no-control or traffic responsive metering. In developing the freeway model, the project further refined the processes needed to calibrate and test MILOS for a specific freeway. The second objective was only partially met. The interfaces within MILOS have been refined, but only some of the interfaces with the real-time data have been established. The interface for data flowing from the freeway management system into MILOS has been established. An interface for delivering ramp-metering rates from MILOS to the field via the freeway management system has not been established. The development of this second interface via a subcontract was determined to be infeasible within the project budget. Because of this, the third objective has not yet been achieved. The effectiveness of MILOS and coordinated ramp metering in the field will not be proven until this third objective can be achieved.</p>					
17. Key Words MILOS, RHODES, Coordinated Ramp Metering, Freeway Simulation		18. Distribution Statement Document is available to the U.S. Public through the National Technical Information Service, Springfield, Virginia, 22161		23. Registrant's Seal	
19. Security Classification Unclassified	20. Security Classification Unclassified	21. No. of Pages 46	22. Price		

SI* (MODERN METRIC) CONVERSION FACTORS

APPROXIMATE CONVERSIONS TO SI UNITS					APPROXIMATE CONVERSIONS FROM SI UNITS				
Symbol	When You Know	Multiply By	To Find	Symbol	Symbol	When You Know	Multiply By	To Find	Symbol
<u>LENGTH</u>					<u>LENGTH</u>				
in	inches	25.4	millimeters	mm	mm	millimeters	0.039	inches	in
ft	feet	0.305	meters	m	m	meters	3.28	feet	ft
yd	yards	0.914	meters	m	m	meters	1.09	yards	yd
mi	miles	1.61	kilometers	km	km	kilometers	0.621	miles	mi
<u>AREA</u>					<u>AREA</u>				
in ²	square inches	645.2	square millimeters	mm ²	mm ²	Square millimeters	0.0016	square inches	in ²
ft ²	square feet	0.093	square meters	m ²	m ²	Square meters	10.764	square feet	ft ²
yd ²	square yards	0.836	square meters	m ²	m ²	Square meters	1.195	square yards	yd ²
ac	acres	0.405	hectares	ha	ha	hectares	2.47	acres	ac
mi ²	square miles	2.59	square kilometers	km ²	km ²	Square kilometers	0.386	square miles	mi ²
<u>VOLUME</u>					<u>VOLUME</u>				
fl oz	fluid ounces	29.57	milliliters	mL	mL	milliliters	0.034	fluid ounces	fl oz
gal	gallons	3.785	liters	L	L	liters	0.264	gallons	gal
ft ³	cubic feet	0.028	cubic meters	m ³	m ³	Cubic meters	35.315	cubic feet	ft ³
yd ³	cubic yards	0.765	cubic meters	m ³	m ³	Cubic meters	1.308	cubic yards	yd ³
NOTE: Volumes greater than 1000L shall be shown in m ³ .									
<u>MASS</u>					<u>MASS</u>				
oz	ounces	28.35	grams	g	g	grams	0.035	ounces	oz
lb	pounds	0.454	kilograms	kg	kg	kilograms	2.205	pounds	lb
T	short tons (2000lb)	0.907	megagrams (or "metric ton")	mg (or "t")	Mg	megagrams (or "metric ton")	1.102	short tons (2000lb)	T
<u>TEMPERATURE (exact)</u>					<u>TEMPERATURE (exact)</u>				
°F	Fahrenheit temperature	5(F-32)/9 or (F-32)/1.8	Celsius temperature	°C	°C	Celsius temperature	1.8C + 32	Fahrenheit temperature	°F
<u>ILLUMINATION</u>					<u>ILLUMINATION</u>				
fc	foot candles	10.76	lux	lx	lx	lux	0.0929	foot-candles	fc
fl	foot-Lamberts	3.426	candela/m ²	cd/m ²	cd/m ²	candela/m ²	0.2919	foot-Lamberts	fl
<u>FORCE AND PRESSURE OR STRESS</u>					<u>FORCE AND PRESSURE OR STRESS</u>				
lbf	poundforce	4.45	newtons	N	N	newtons	0.225	poundforce	lbf
lbf/in ²	poundforce per square inch	6.89	kilopascals	kPa	kPa	kilopascals	0.145	poundforce per square inch	lbf/in ²

SI is the symbol for the International System of Units. Appropriate rounding should be made to comply with Section 4 of ASTM E380

TABLE OF CONTENTS

PREFACE.....	1
1 INTRODUCTION.....	3
1.1 BACKGROUND.....	3
1.2 PROJECT HISTORY.....	3
1.3 SUMMARY.....	6
2 RAMP METERING WITH MILOS.....	7
2.1 MILOS CONTROL STRUCTURE.....	7
2.1.1 Area Wide Controller.....	8
2.1.2 Predictive-Cooperative Real-Time Control.....	9
2.2 FREEWAY SIMULATION MODEL WITH RAMPS.....	11
3 I-10 MODEL DEVELOPMENT – DATA AND CALIBRATION.....	12
3.1 FREEWAY STRUCTURE.....	13
3.2 OTHER RAMP METERING STRATEGIES.....	14
3.3 TRAFFIC FLOW SCENARIO & SIMULATION EXPERIMENTS.....	15
3.3.1 Short Scenario.....	15
3.3.2 Simulation Calibration Using the Short Scenario.....	16
3.3.3 Long Scenario.....	19
3.3.4 Simulation Results from Long Scenario.....	20
4 INTERFACE DEVELOPMENT.....	25
4.1 FREEWAY REAL-TIME DATA INTERFACE.....	25
4.1.1 Connecting with FMS.....	26
4.1.2 Real Time Data Conversion.....	26
4.2 MILOS INTERACTION WITH REAL-TIME DATA.....	26
4.2.1 Traffic Interchange Interactions.....	29
4.2.2 MILOS.out.....	31
5 CONCLUSIONS.....	32
5.1 RESEARCH CONTRIBUTIONS.....	32
5.2 FUTURE RESEARCH ISSUES.....	32
APPENDIX A: DESCRIPTION OF MATLAB SOFTWARE.....	38
APPENDIX B: CONVERSION OF EMBEDDED CONSTANTS.....	40
APPENDIX C: EXAMPLE OUTPUT FROM TI SIMULATOR/QUEUE ESTIMATOR.....	41
REFERENCES.....	46

LIST OF TABLES

Table 1 - Details of I-10 Test Area	14
Table 2 - Metering Rates for Traffic Responsive Volume/Speed Metering	15
Table 3 - Long Scenario Upstream Volumes Entering I-10 Simulation at 83 rd Avenue (VPH)	19
Table 4 - Long Scenario Average On-Ramp Volumes Every 15 Minutes (5 AM To 8 AM, VPH)	20
Table 5 - Long Scenario Average On-Ramp Volumes Every 15 Minutes (8 AM To 11 AM, VPH).....	20
Table 6 - Real Time Files Read by MATLAB	27
Table 7 - Formation of Real Time Files.....	28

LIST OF FIGURES

Figure 1 - Software Interface Modules (1 To 4) Between FMS And MILOS	4
Figure 2 - The MILOS Control Architecture.....	7
Figure 3 - Map Of I-10 Study Area From 83rd Avenue To 35th Avenue	13
Figure 4 - Example Of Speed/Volume Data I-10 At 58th Avenue For All Of 1999 From 7:45-8:00 AM...	18
Figure 5 - Density With No Ramp Control	21
Figure 6 - On Ramp Flows (VPH) With No Control	21
Figure 7 - Queues With No Control.....	21
Figure 8 - Density With Traffic Responsive With Queue Management Control.....	22
Figure 9 - Metering Rates (VPH) With Traffic Responsive With Queue Management Control	22
Figure 10 - Queues With Traffic Responsive With Queue Management Control	22
Figure 11 - Density With MILOS Control	23
Figure 12 - Metering Rates (VPH) With MILOS Control.....	23
Figure 13 - Ramp Queues With MILOS Control	23
Figure 14 - Summary Of Performance I-10 Simulation Results.....	24
Figure 15 - MILOS Software Interactions	25
Figure 16 - Sources Of Traffic Intersection Demand For A Ramp.....	29
Figure 17 - Sequence Of MILOS Traffic Intersection DLL Interactions.....	30
Figure 18 - Abstraction Levels For Traffic Interchange Software.....	30

LIST OF ACRONYMS

ADOT	Arizona Department of Transportation
ATLAS	Advanced Transportation, Logistics, Algorithms and Systems
ATRC	Arizona Transportation Research Center
CPLEX	Optimization Software from ILOG, Inc.
FMS	Freeway Management System
ITS	Intelligent Transportation Systems
MILOS	Multi-Objective, Integrated, Large-Scale, Optimized System
RHODES-ITMS	the Real Time, Hierarchical, Optimized, Distributed, Effective System- Integrated Traffic Management System
MAG	Maricopa Association of Governments
MATLAB	Programming software from The MathWorks, Inc.
O/D Matrix	Origin-Destination Matrix
PC	Personal Computer
PC-RT	Predictive-Cooperative, Real-Time
TAC	Technical Advisory Committee
TI	Traffic Interchange
VPHPL	Units of "vehicles per hour per lane"

PREFACE

This report documents the work performed on the Real Time, Hierarchical, Optimized, Distributed, Effective System-Integrated Traffic Management System (*RHODES-ITMS*) Ramp Metering Project. The Arizona Department of Transportation (ADOT) funded this research effort. The scope of this project was to test coordinated ramp metering via simulation, and develop the interfaces to field test the software. The development of the Multi-Objective, Integrated, Large-Scale, Optimized System (MILOS) architecture and algorithms was addressed in an earlier phase of the RHODES-ITMS Program. This report addresses the latest phase of the program that resulted in: (1) Development of a simulation model for a 7-mile eastbound segment of I-10 in Phoenix, just west of the I-10/I-17 interchange, and (2) Refinement of the interfaces that bring data from the freeway management system (FMS) to the MILOS ramp metering software. In summary, this phase involved:

- collection of data to build and validate the I-10 freeway model,
- development of a realistic traffic scenario to test the MILOS system with,
- evaluation of MILOS' performance in this scenario, and
- development of software interfaces to get real-time freeway status to MILOS.

The major outcomes of this project were as follows: (1) The I-10 model was constructed and validated. This effort was hampered by the availability of reliable data from the FMS system. Even with 100% reliable information, it became clear that a model that mimics reality exactly is not worth the tremendous effort required to achieve that level of fidelity. (2) The traffic scenario was developed and served as a realistic basis for comparison. (3) MILOS' performance in the simulation experiments was excellent, achieving drastically improved freeway flow, throughput and travel times. This was accomplished at the expense of large queues dispersed at the ramps throughout the system. (4) Some success was achieved in development of interfaces. This success occurred in the interfaces that bring data from the FMS to MILOS, and in developing queue estimation procedures that take information from the interchange detectors and estimate ramp queues. An interface for delivering ramp-metering rates from MILOS to the field was determined to be outside of the scope of the budget for the current project and was not pursued.

This report was written primarily by the principal investigator, **Frank W. Ciarallo**, and by co-investigator, **Pitu B. Mirchandani**, both of the Advanced Transportation, Logistics, Algorithms and Systems (ATLAS) Research Center, Systems and Industrial Engineering Department at the University of Arizona. Also, several other individuals have contributed towards the writing, software development and/or data gathering. In particular, the efforts of the following individuals are acknowledged:

Douglas Gettman	Siemens Gardner Transportation System Inc., Tucson, AZ
James Grabher	Raytheon Missile Systems Inc., Tucson, AZ
Srinivas Badinarayanan	Computer Science Department, University of Arizona, Tucson, AZ

In addition, the principal investigators wish to acknowledge their appreciation to the Project's **Technical Advisory Committee** (TAC) whose continual active participation, technical input and support resulted in the *RHODES-ITMS* results being even more relevant to traffic engineering and control. The following individuals served on the TAC at various times:

Alan Hansen	Federal Highway Administration (FHWA)
Tom Fowler	Kimley-Horn & Associates (formerly at FHWA)
Tim Wolfe	ADOT Transportation Technology Group
Dan Powell	Willdan & Associates (formerly at ADOT)
Tom Parlante	ADOT Traffic Engineering
Manny Agah	ADOT Freeway Management
Phil Carter	ADOT Freeway Management
Glenn Jonas	ADOT Freeway Management
Jerry Pfeifer	ADOT Freeway Management
Jim Shea	Retired (previously at ADOT)

Sarath Joshua	Maricopa Association of Governments - MAG (formerly at ADOT-ATRC)
Jim Decker	Traffic Operations, City of Tempe
Ron Amaya	Traffic Engineering Division, City of Peoria (formerly at City of Tempe)
Dave Wolfson	Maricopa County Department of Transportation (MCDOT)
Ben McCawley	City of Chandler (formerly at MCDOT)
Pierre Pretorius	Kimley-Horn & Associates (formerly at MCDOT)
Don Wiltshire	Maricopa Association of Governments (formerly at MCDOT)
Scott Nodes	Traffic Operations, City of Peoria (formerly at City of Phoenix)
Steve Owen	RHODES-ITMS Project Manager, ADOT-ATRC

The contents of this report reflect the views of the authors who are responsible for the facts and the accuracy of the data presented herein. The contents do not necessarily reflect the official views of the Arizona Department of Transportation, or the Federal Highway Administration. This report does not constitute a standard, specification or regulation.

1. INTRODUCTION

1.1 BACKGROUND

Traffic congestion is a growing problem in urban freeway networks. Ramp metering is one of the available traffic management tools that have been shown to reduce delays and increase capacity. Because coordinated ramp metering is an Intelligent Transportation System (ITS), these benefits can be realized without significant spending on additional travel lanes or adding miles of freeway.

Congestion during commuting hours makes up a large fraction of total vehicle-hours of delays. The remainder of delays is mostly due to non-recurring events, such as crashes and other anomalous events. Effective management of peak commuting times and accident conditions on freeways will thus have the largest impact on freeway delays.

Freeway congestion is a cost to society because of increased times for travel due to excessive delays. Side effects of congestion include degradation of air quality and increased fuel consumption. Driver safety is also jeopardized in congested freeways with areas of drastically different speeds.

The goal of ramp metering is to smooth freeway flow to attain consistent throughput rates that maximize the use of the vehicle-carrying capacity of the freeway system. This occurs because metered on-ramp flows reduce or eliminate the “shock wave” created by large platoons of on-ramp vehicles merging with freeway traffic. A side benefit of consistent throughput rates is predictable, consistent vehicle trip times. The queues at the ramps will discourage routes with high societal costs (due to congestion). Finally, reduction in speed variation and weaving behavior leads to fewer crashes.

To achieve these benefits, ramp metering must incur direct costs related to a more complex control system, and costs related to queues at the on-ramps. Thus in locations where ramp metering has potential, the goal of improved freeway flows must be considered together with the negative effects of large ramp queues. The time spent by relatively few vehicles in the ramp queues can easily be offset by the improved travel times of many vehicles on the freeway traveling at free-flow speeds. When significant queues build, ramp metering implicitly favors through traffic over local traffic and short trips. Excessive queues at the ramps may create additional costs if they extend into the adjacent traffic interchange, effecting movement of vehicles through the interchange.

The factors outlined above define the essential tradeoffs in effective ramp metering.

1.2 PROJECT HISTORY

The Real Time, Hierarchical, Optimized, Distributed, Effective System-Integrated Traffic Management System (RHODES-ITMS) Program addresses the design and development of a real-time traffic adaptive control system for an integrated system of freeways and arterial roads. The overall program was initiated in December 1993, jointly funded by the Arizona Department of Transportation (ADOT) through the State

Planning and Research Program budget and the Maricopa Association of Governments (MAG). The RHODES-ITMS program is overseen by ADOT's Arizona Transportation Research Center (ATRC). Starting in 1996, the RHODES-ITMS Corridor Control Project developed the Multi-Objective, Integrated, Large-Scale, Optimized System (MILOS) architecture for coordinated ramp metering. Under the direction of Pitu Mirchandani and K. Larry Head of the Systems & Industrial Engineering Department at the University of Arizona, Douglas Gettman developed and tested the MILOS architecture for his Ph.D. dissertation. The background for and development of the MILOS architecture are described in detail in ADOT Report #FHWA-AZ99-462.

In August 1998, the program was extended by ADOT with plans to conduct a field test project of the MILOS technology. The new project focused on the section of I-10 eastbound near Phoenix, between 83rd Avenue and 27th Avenue. This section of freeway has 6 metered on-ramps and is a location with recurring congestion. Also, this section of freeway has detectors and ramp meters that are part of the ADOT freeway management system (FMS). The original tasks set out for the project included 1) development of a simulation model for the I-10 test area similar to that used in the Gettman dissertation for SR202, 2) evaluation of MILOS' performance in the simulated environment, 3) development and testing of the interfaces necessary to use MILOS in the field via the FMS, including real-time input from detectors to the MILOS software, and real-time outputs from MILOS to ramp meter controllers and 4) a real-time test using MILOS to control the ramp meters in the field. The new project included the original MILOS team, in addition to Frank Ciarallo from the Systems & Industrial Engineering Department and several students. These included undergraduate student Brett Sharon, and graduate students Jim Grabher and Srinivas Badinarayanan.

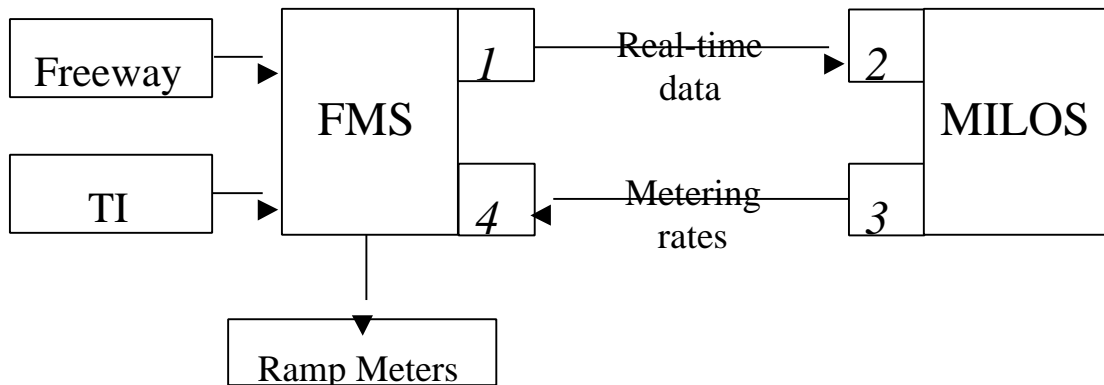

Figure 1 - Software Interface Modules (1 to 4) Between FMS and MILOS

Figure 1 schematically shows the initial design of four software interface modules required to allow communications between MILOS and the FMS. Module 1 extracts the required detector data from the full FMS data stream and makes it available to Module 2 every 20 seconds. This includes freeway and interchange detector information. Module 2 is called from within MILOS and accesses the data stream from Module 1, translating that information into the speed, volume and queue data required by MILOS. Module 3 takes the metering rates set by MILOS and formats them for Module 4, including rounding to the appropriate range and creating any other commands required for interface with Module 4. Module 4 translates the ramp metering commands from Module 3 and communicates them through the FMS to the ramp controllers. For safety reasons, Module 4 should only allow MILOS access to the ramp meter controllers, and not the full set of commands that could be transmitted to the FMS (for example, to control variable message signs).

In November 1998, the initial plan was for the University of Arizona team to be responsible for development of the modules that interact directly with MILOS (Modules 2 and 3). Via a subcontract, Kimley-Horn & Associates were to be responsible for Module 4. Module 1 was to be developed jointly by the University of Arizona team with support from Kimley-Horn. In February 1999, after receiving a bid for the Kimley-Horn portion of the work, the scope of the plan was changed. Because of the unexpectedly large expense for Module 4, it was removed from the scope of the current project. This was a difficult choice, since without Module 4, it is impossible to test the effectiveness of MILOS, because metering rates cannot be communicated to the field. It was decided that a full test of MILOS in the field (originally one of the 4 main project goals) would be deferred to a later project.

During the spring and summer of 1999 the information on the geometry of the freeway (number of lanes, location and length of on-ramps and off-ramps, length of segments, locations of detectors, etc.) was collected and encoded into a simulation model. Also during this time, the MILOS software had to be modified to work with an upgraded version of the CPLEX optimization software. The effort to calibrate the macroscopic traffic model took place between winter 1999 and summer 2000. This entailed working with multiple data sets of varying levels of detail (15 minute counts down to 1 minute detector counts). This effort was hampered by malfunctioning detector stations, and stations that were out of service during freeway maintenance operations. This effort also included some changes to the structure of the simulation model. Following the calibration effort, a traffic scenario based on a typical morning rush period was developed and used as the basis for the simulation testing. The running of the simulation tests took place in summer and fall of 2000.

In summer of 1999, the development of Modules 1 and 2 began, aided in the fall of 1999 by the use a "recorded data interface". This interface allowed the development of Module 1 using software that delivered recorded freeway data using the same interface that is presented by the FMS. This allowed development and debugging of Module 1 without being connected to the "live" FMS. During this development process, it was found that the FMS data stream was not providing variables related to the

traffic interchanges (TI). This was a serious problem, because vehicle flows from the TI detectors are required to estimate the queue lengths at the ramp meters. In May of 2000 it was decided that a TI simulation would be used to develop the procedures for estimating ramp queues using simulated TI vehicle flows. This simulation was developed using CORSIM, with the portions of Module 1 that interact with the simulation coded so that they would easily be merged with the other portions of Module 1. The development of the TI simulation was completed in December 2000.

1.3 SUMMARY

The remainder of this document is organized as follows. Section 2 gives an overview of the structure and internal operation of the MILOS system, with a description of the hierarchical optimization framework that MILOS is based on. Section 3 describes the effort to use data from the field to build and calibrate the I-10 simulation model used to evaluate MILOS. This includes the construction of a realistic traffic scenario and the results of running MILOS in this scenario. Section 4 describes the interfaces both within MILOS and between MILOS and the field. The internal interfaces allow communication between the MATLAB environment, and the CPLEX optimization software. The interfaces between MILOS and the FMS system are necessary for MILOS to receive real-time information for operation in the field. Section 5 provides a summary of findings and recommendations. Section 6 includes supporting documents.

2 RAMP METERING WITH MILOS

MILOS is an acronym for *Multiple-objective, Integrated Large-scale, and Optimized System*. The MILOS architecture is novel in the way that it explicitly considers the interaction between the surface-street system and the freeway system. In MILOS, the sometimes-competing objectives of these systems are managed by using a multi-objective solution methodology. MILOS is a hierarchical freeway on-ramp control system that decomposes the large-scale freeway ramp-metering problem into a series of optimization problems of varying temporal and spatial resolutions. The optimization problems are re-solved as the parameters and conditions of the system change to continually adjust the control strategy to the real-time behavior of the system. In addition to this, to mitigate the unpredictability of the future system state, a predictive, scenario-based optimization scheme is implemented in real-time to prepare the local subsystem for the next short-term stochastic disturbance.

2.1 MILOS CONTROL STRUCTURE

Figure 2 depicts the hierarchical structure of MILOS. There are two levels in the hierarchy: An area-wide coordinator and, for each on-ramp, a predictive-cooperative real-time rate regulator. The planning and control activities proceed in a rolling horizon framework: the planning horizon extends forward

Figure 2 - The MILOS Control Architecture

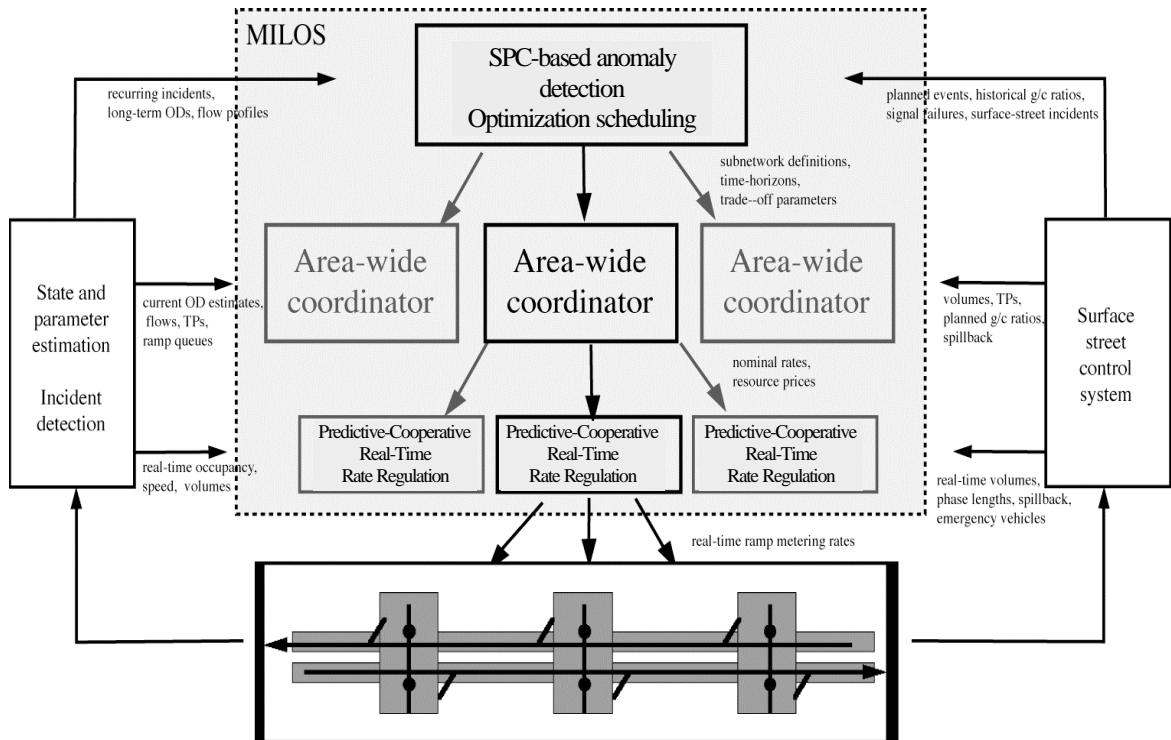

in time, covering many opportunities to change the metering rate, but only the current system is applied to the system. The metering rate is recomputed and applied at intervals that are shorter than the planning horizon.

2.1.1 Area Wide Coordinator

The area-wide coordinator provides tactical decision-making for the MILOS hierarchy. It assigns target ramp metering rates for the medium-term (10-20 minutes) to maximize freeway throughput, balance ramp queue growth rates, and minimize queue spill-back into the adjacent surface-street interchanges. It is based on a rolling horizon implementation of a multiple-criteria, quadratic programming optimization problem. Queue growth rates at adjacent interchanges are planned according to the relative congestion of the interchanges.

A brief mathematical description of the area wide coordination optimization problem follows:

$$\max_{r \in R} \sum_{i=1}^N (1 + 2 \mathbf{bgc}_i d_i) r_i - \mathbf{bgc}_i r_i^2 - \mathbf{b}_i \mathbf{gc}_i z_i^2$$

Equation 1

subject to

1. $\sum_{i=1}^j A_{i,j} r_j \leq CAP_j \quad \forall j$
 2. $(d_i - r_i) T - z_i \leq Q_i \quad \forall i$
 3. $r_{MIN} \leq r_i \leq r_{MAX} \quad \forall i$
 4. $c_i = \frac{\sum_{m=1}^M \frac{v_{m,i}}{C_{m,i}}}{\max_i(c_i)} \quad \forall i$
 5. $d_i = \mathbf{r}_{R,NB} d_{NB} + \mathbf{r}_{L,SB} (1 - \mathbf{r}_{R,SB}) d_{SB} + \mathbf{r}_{T,EB} d_{EB} + \frac{q_i(0)}{T} \quad \forall i$
- $$\mathbf{g} = \frac{\left(\sum_{i=1}^N d_i \right)^2}{\sum_{i=1}^N c_i (d_i - r_{i,MIN})}$$

The variables in this formulation are defined below:

- ◆ N is the number on-ramps
- ◆ M is the number of off-ramps
- ◆ d_i is the demand (veh/hr) at each on-ramp i
- ◆ r_i is the ramp metering rates (veh/hr) at ramp i
- ◆ \mathbf{b} is a weighting factor. Setting \mathbf{b} large will increase the importance of balancing ramp queues and setting \mathbf{b} small will decrease the importance on balancing queues and increase the importance of maximizing freeway throughput.
- ◆ c_i is a congestion weighting factor for interchange i
- ◆ s_i is the saturation flow rate of the ramp i

- ◆ CAP_j is the physical limit of freeway capacity for segment j
 - ◆ $A_{i,j}$ is the proportion of the flow entering at ramp i that continues through link j en route to its destination
 - ◆ $r_{i,MAX} = \min(d_i, s_i) \cdot r_{i,MIN}$
 - ◆ $r_{i,MIN}$ is the slowest rate acceptable to drivers, which could be as low as zero if the ramp was allowed to be and/or capable of being fully closed
 - ◆ $C_{m,i}$ is the capacity of phase m at interchange i
 - ◆ $V_{m,i}$ is the offered volume for phase m at interchange i .
 - ◆ $q_i(0)$ is the queue length at the ramp when the optimization begins
 - ◆ $p_{R,NB}$, $p_{L,SB}$, and $p_{T,EB}$ are the current probabilities of turning right, left, and through, respectively at each of the approaches to the interchange feeding ramp i
 - ◆ d_{NB} , d_{SB} , and d_{EB} are the demands on the northbound, southbound, and eastbound approaches to interchange i , respectively. These definitions assume an eastbound freeway for demonstration.
 - ◆ z_i is the extra capacity allocated at each ramp queue i to accommodate the flow at that ramp
 - ◆ T is the optimization time horizon
-

The goals of the area wide coordinator are to:

1. plan coordinated metering rates for recurrent congestion.
2. identify short-term flow fluctuations that require re-resolution of the area-wide and real-time optimization problems.
3. react to changes in the relative congestion levels of the interchanges.
4. balance queue growth rates in the network.
5. respond to non-recurrent congestion generated by crashes.

2.1.2 Predictive-Cooperative Real-Time Control

At each ramp, the predictive-cooperative real-time (PC-RT) controller receives a table of set point metering rates and desired freeway states from the area-wide coordinator. The real-time controller then solves optimization problems with a time horizon of minutes, with direct influence over a single ramp meter and a small section of freeway. It solves optimization problems based on a linearized description of the response of freeway flow to ramp metering rates. These optimization problems attempt to maximize additional travel timesavings, beyond those due to the area-wide coordination. It attempts to be proactive in modifying the nominal metering rates provided by the area-wide coordinator. This is accomplished by considering a small set of scenarios of possible ramp and freeway flows in the next few minutes. The PC-RT formulation pro-actively plans to utilize opportunities to disperse queues or hold back additional vehicles when freeway and ramp demand conditions are appropriate. The cost coefficients of this optimization problem are linked to the solution of the area-wide coordination problem by using output variables from the solution to the area-wide coordination problem.

The PC-RT algorithm addresses the need to integrate the effort of the freeway control system with the concerns of the surface street control system. It does this by responding to statistically significant short-

term fluctuations in the stochastic vehicle flows from the upstream freeway and at the ramp. PC-RT does this while continuing to follow the nominal ramp metering rates recommended by the area wide coordinator. The metering rates from PC-RT thus do not deviate significantly from the nominal rates set by the area-wide coordinator. Recall that at the area-wide coordination level, the vehicle flows are considered constant.

A more detailed description of the mechanics of the PC-RT procedure follows, based on the notation defined in Section 2.1.1: The basic function of the PC-RT rate regulation algorithm is to exploit, at any time k , the excess local capacity $\mathbf{r}_j(k) < \mathbf{r}_{j,N}$ and $q_i(k) < q_{i,N}(k)$ in the freeway/ramp system by reacting in the following ways to the *fundamental* combinations of predicted ramp demand and predicted upstream freeway flow:

- (1) *increase* the metering rate when the freeway density is *lower* than the nominal density and the ramp demand is *higher* than nominal,
- (2) *decrease* the rate when the ramp demand is *lower* than nominal and freeway density is *higher* than nominal
- (3) *increase* the rate when ramp demand is *lower* than nominal and freeway density is *lower* than nominal
- (4) *increase* or *decrease* the metering rate according to a *trade-off* solution when ramp demand is *higher* than nominal and freeway density is *higher* than nominal.

How much to decrease or increase the rate $r_i(k)$ from the nominal setting $r_{i,N}$ is specified by formulation of a linear programming optimization problem (LP). This LP is formulated with a linearized description of the macroscopic freeway flow equations (from Chapter 4) about the nominal *equilibrium state* $(\mathbf{r}_{j,N}, \mathbf{u}_{j,N}, r_{i,N})$ and a linear description of queue growth about the nominal queue-growth *trajectory* $q_{i,N}(k)$. The cost function of this LP optimization problem is a weighted sum of travel-time savings in each section of the freeway and on the ramp approaches. The weights of each state-variable are derived from the dual multipliers \mathbf{I}_k and constraint slack \mathbf{e}_k values of the solution to the upper-layer area-wide QP optimization problem. In this manner, a trade-off between travel-time savings on the ramp and on the freeway is based on the *current* interchange conditions (i.e. how important it is to manage spillback at *this* ramp) and the conditions in critical freeway sections.

The PC-RT rate regulation algorithm can be described as a three-step process:

- (1) Given that a *significant* deviation from the upstream freeway or ramp demand nominal flow is detected, *predict* several possible subsequent flows to the ramp and the upstream freeway segment,
- (2) Given these predicted possible future *scenarios*, solve an LP optimization problem for each predicted scenario that reduces queuing time on the ramp and/or reduces the possibility for congestion on the freeway over the next few minutes, and

- (3) In the next optimization interval, collect the "actual" upstream freeway flow and ramp demand, compare the actual flow to the predicted scenarios, and apply the appropriate metering rate for the scenario that best matches the actual flow.

A *rolling-horizon* framework is used in the three-step process listed above. Thus, the PC-RT optimization problems are solved for a 5 to 7 minute predictive time-horizon, but the metering rate is only applied for the first 1-2 minutes of the time horizon before the problem is possibly re-evaluated due to the stochastic fluctuations.

2.2 FREEWAY SIMULATION MODEL WITH RAMPS

The original algorithm used an O/D matrix or route-proportional matrix. An O/D matrix shows the proportion of the freeway flow entering at a ramp that continues through the various portions of the freeway in question. This data structure actually contained more information than is needed and is hard to derive. The information the algorithm actually needs is what proportion of the freeway flow exits at each off-ramp. The O/D matrix not only contains this but also how much of that traffic came from each on-ramp. A matrix of turning ratios showing what proportion of the freeway traffic exits at each off-ramp is much easier to derive. The simulation model and optimization modules of MILOS were modified to accept the turning ratio information in place of the O/D matrix specification.

3 I-10 MODEL DEVELOPMENT – DATA AND CALIBRATION

Evaluating the effectiveness of the MILOS ramp metering strategy using simulation required an accurate description of the physical structure of the freeway (number of lanes, location of on/off-ramps, queueing capacity at the ramps), as well as a realistic estimate of the flow of traffic (on-ramp flows, off-ramp turning probabilities). Because the flow of traffic varies throughout the day, a “scenario” based approach is reasonable, described by average volumes at the ramps that vary throughout the day. This section describes the procedures used to create the simulated I-10 freeway structure and 2 traffic scenarios.

The calibration of the macroscopic simulation is important both for the validity of the simulation comparisons, but also for proper operation of the PC-RT module. The PC-RT module (described in Section 2.1.2) uses a linearized version of the macroscopic model to predict traffic flows in the near future. The calibration effort revealed a significant problem with the reliance of the MILOS algorithm (or any algorithm needing real-time measurements) on detector counts. Unexpectedly, much of the data available on I-10 in this location was found to be corrupt in some way, due to issues such as missing detectors, cut communication to detectors, or detectors (and/or data collection software?) producing spurious measurements. This was due to malfunctioning detectors or detector stations, as well as stations down due to freeway maintenance activity.

For example, between 81st Avenue and 5th Avenue there are 27 detector stations on I-10 eastbound. In one large data set:

- 1) 5 of these locations had ALL detectors operating and producing reliable data,
- 2) 7 locations had one or more detectors producing spurious measurements for some portion of the day, 6 locations were completely non-reporting, and
- 3) the remaining 9 locations had one or two lanes that were not reporting (for the period of 5:45 AM – 12:00 midnight on 5/3/00 – the period from 12 midnight to 5:45 AM has very sparse traffic and leads to confusion in the data analysis process).

It should not be overlooked, however, that relative comparison statistics of the MILOS method with the other control methods using the “geometrically” correct model of I-10 with a possibly spurious model of the traffic dynamics would still be useful. This is because all of the control methods would be evaluated with the same traffic model. It is recommended that calibration attempts be curbed in future work and more emphasis placed on processing raw detector data into useable data streams for real-time operation of the algorithm. It is also possible that using a possibly poorly calibrated linearized macroscopic model for prediction of future effects in the PC-RT local control optimization problems should not cause large disparity in the control efficacy simply because the model is poorly calibrated.

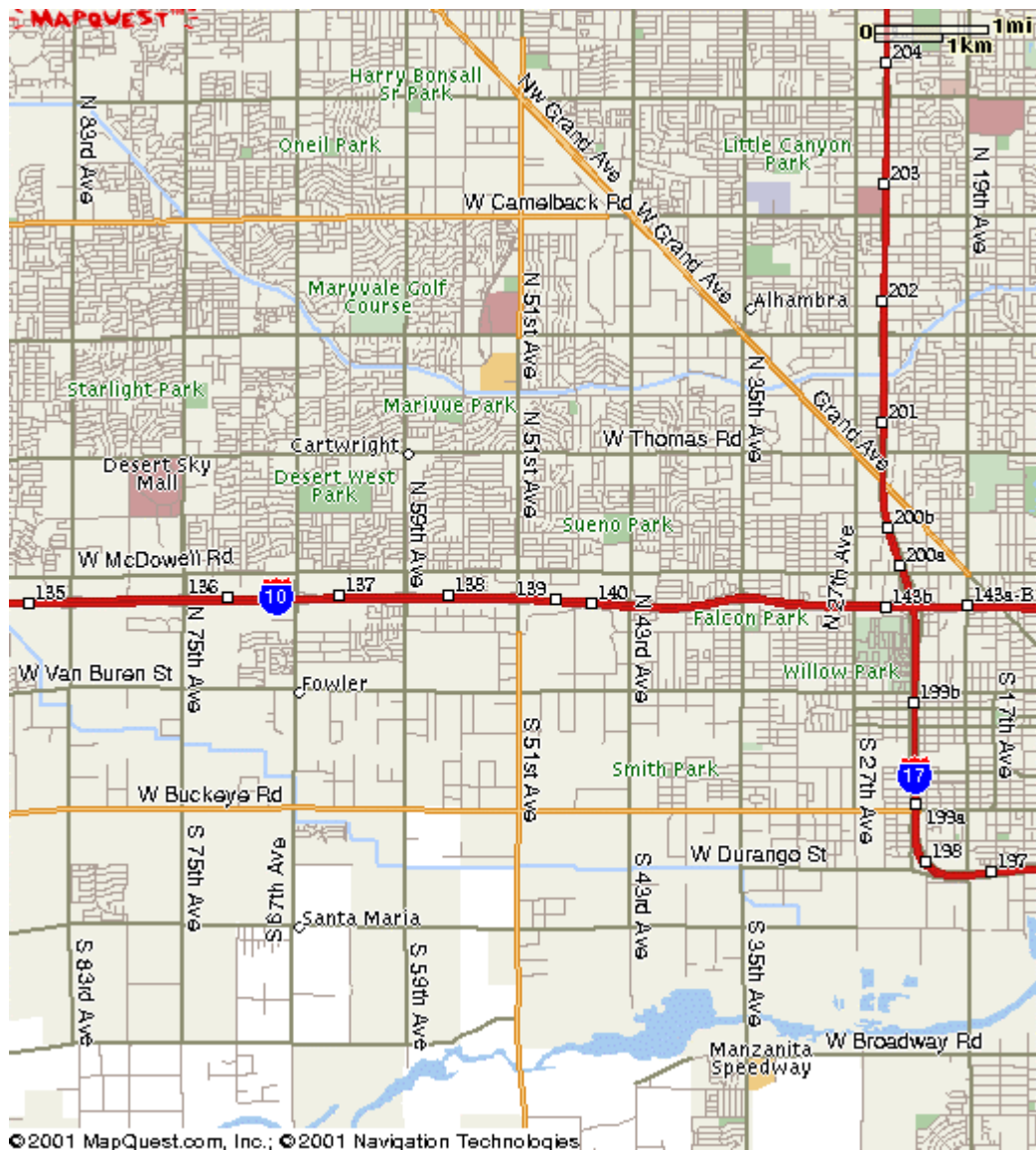

Figure 3 - Map of I-10 Study Area from 83rd Avenue to 35th Avenue

(source <http://www.mapquest.com>)

3.1 FREEWAY STRUCTURE

The preliminary MILOS evaluation was based on a simulation model of the SR202 in Phoenix, AZ. The TAC members for the new project suggested I-10 Eastbound 81st Avenue – 22nd Avenue for the test location given the availability of data on that stretch of freeway and the existence of ramp meters in that section. Figure 3 is a map of the area, covering I-10 Eastbound from exits 135 to 143. This stretch of freeway has six metered on-ramps and seven off-ramps. The coordinated section ends just before the I-10/I-17 interchange (the “stack”) and is a location with recurring congestion. Also, this section of freeway has detectors and ramp meters that are part of the ADOT freeway management system (FMS).

MILOS uses a macroscopic model of traffic on the freeway, in which aggregate vehicle movement is treated as a fluid-like flow. The macroscopic model is described in detail in ADOT Report #FHWA-AZ99-462. The freeway is separated into “segments” which are then further decomposed into “sections” roughly 500m in length. Sections are the smallest spatial resolution of the traffic state variables in the simulation. The boundaries of segments are placed where there is a physical change in the freeway geometry (lane drop or add, on- or off-ramp). Table 1 describes the physical parameters of the I-10 study area. Note that segments 10 and 11 describe the freeway near the I-10/I-17 interchange, and are not represented in the simulation. The I-10 simulation model uses only the first nine segments.

Table 1 - Details of I-10 Test Area

Segment	1	2	3	4	5	6	7	8	9	10	11
Length (m)	1500	1750	1625	1750	1625	1550	1750	1000	500	625	1050
Lanes*	3	3	3	3	3	3	3	3	4	3	3
Location	86 th -79 ^d	79 th -71 ^s	71 st -63 rd	63 rd -54 th	54 th -46 th	46 th -39 ^d	39 th -31 ^s	31 st -26 th	26 th -24 ^d	24 th -21 ^s	21 st -16 th
On Ramp	83 rd	75 th	67 th	59 th	51 st	43 rd	35 th	-	-	-	I-17
Storage Area (m)	250	375	250	375	250	250	175	-	-	-	0
Lanes On Ramp	4**	1	1	1	1	1	1	-	-	-	2
Off Ramp	83 rd	75 th	67 th	59 th	51 st	43 rd	35 th	27 th	I-17	-	-
Lanes Off Ramp	1	1	1	1	1	1	1	2	2	-	-

* Lanes do not include HOV/carpool lane.

** Three freeway lanes and one on-ramp at 83rd.

3.2 OTHER RAMP METERING STRATEGIES

In this experiment, MILOS was compared to the no-control case, where traffic is allowed to flow without metering onto the freeway and a traffic responsive volume/speed metering with queue management: As reported in Report #FHWA-AZ99-462, Table 2 relates the metering rate at a given ramp to the freeway volume or speed just upstream of the metering location. Using volume and speed measurements from the upstream detectors, the values are compared with column 2 in Table 2 beginning from the top and proceeding to the bottom. If the mainline measured volume is less than the given threshold in column 2, *or* if the mainline measured speed is greater than the threshold found in column 3, then the corresponding metering rate in column 1 is applied. Each minute, the metering rate is adjusted using this procedure, after the mainline speed and volume measurements are collected.

Metering Rate (veh/hr)	Mainline Volume Threshold (veh/hr/lane)	Mainline Speed Threshold (miles/hr)
240	1980	10
360	1860	30
480	1560	46
600	1080	54
720	720	57
900	480	60

Table 2 - Metering Rates for Traffic Responsive Volume/Speed Metering

3.3 TRAFFIC FLOW SCENARIO & SIMULATION EXPERIMENTS

Lower fidelity data (15-minute aggregation) were used to create a short traffic flow scenario and higher fidelity data (1-minute aggregation) to create a longer, more realistic traffic flow scenario. The short scenario was developed primarily to support the calibration of the simulation model parameters. This calibration effort tuned the model of freeway traffic to accurately model actual freeway traffic. The long scenario was intended to model a typical morning rush hour with no accidents on the freeway. The long scenario was used to make the comparisons between 3 ramp metering strategies.

3.3.1 Short Scenario

Based on 15-minute counts for an entire day (May 3, 2000) that were obtained from ADOT, a “short” traffic flow scenario was constructed, representing approximately 90 minutes of traffic flow. This short scenario was used in the calibration effort to “tune” the parameters of the macroscopic simulation model. A short scenario was preferred for the calibration effort because short simulation runs allowed more iterations of the parameter setting/simulation evaluation cycle. The average on- and off-ramp flows were estimated by computing the difference between the measurement up- and down-stream of each ramp. This short scenario had to be massaged considerably from the original data, because using the data directly resulted in some negative turning volumes, at both on- and off-ramps. This anomaly occurred because of missing and non-reporting detectors and the time-scale of the differences. Given the relative scarcity of the observations (15 minute aggregated volumes), calibration attempts allow any number of models to fit the data at 5 or 6 points on the 15-minute time scale, with a wide variation in the freeway flow during the other 14 minutes of the period.

3.3.2 Simulation Calibration Using the Short Scenario

A significant issue of simulation modeling of traffic is the realism of the simulation. Traffic flow is time, location, locale, driver-behavior, geometric, and weather dependent (among other factors). Hence, the goal of any simulation experiment is to model the location and conditions of the test area as accurately as possible. Significant effort during this project was applied to attempting to “calibrate” or compare the performance of the macroscopic flow model with data collected at the test location by ADOT. Early on in the project, several software bugs (related to MATLAB implementation) limited the analysis effort. Identification of these software errors was key in the continued development of the MILOS project.

In the MILOS simulation experiments with SR202, a multi-dimensional calibration optimization search was conducted to locate parameters of the macroscopic model that allowed the model to match the results from a CORSIM simulation model of the SR202. (Refer to Report #FHWA-AZ99-462 for further details on the CORSIM model.) A similar procedure was attempted for the I-10 test location, but the fidelity of the real-time data available was too low (i.e. 15-minute observations) for significant progress to be made. A trial-and-error approach was adopted. The parameters found to match the behavior of vehicles on SR202 were used as a starting point. The resulting parameters found that gave “traffic-like” performance for the I-10 network was similar to the set of parameters for the SR202. Refer to the MATLAB M-files for those parameter definitions and values. This “realistic vehicle traffic” behavior appears to be reasonable for the network conditions. The output of the simulation did not directly match the actual freeway behavior on a minute-by-minute basis, based on the data set made available by ADOT. This was not considered surprising for the following reasons: (1) spatial differentiation in the speed-volume performance of each segment, (2) derivation of turning probabilities and demand modeling in the scenario definition, (3) other modeling assumptions such as homogeneous lane flow and absence of diversion behavior, (4) aggregation of volume, speed, density information across lanes, (5) bad detector data from the freeway. (Refer to the Report #FHWA-AZ99-462 for a further description of the limitations and assumptions of the macroscopic flow model.)

As part of a data analysis effort, the project explored the theory that differing speed-volume performance in the various freeway segments would allow the macroscopic model to more closely match the real freeway measurements. A significant amount of effort was expended to obtain and process volume-speed data provided by ADOT.

Constructing speed-volume curves from a single day of data is difficult. For example, if the freeway does not experience congestion in the section on that day, it is difficult to determine where the transition from free flow to congested flow occurs. Another experiment was conducted to form reliable speed-volume curves by utilizing data from a single time period (e.g. 8:00-8:15AM) for an entire year (1999). (Refer to Figure 4 for an example.) This data was also problematic, because the curves indicate capacities as low as 1200 vphpl and typically in the 1400 vphpl range at locations west of 56th Avenue. It is hypothesized that this is due to the inclusion of the HOV lane data in the computation of “average” vphpl

performance. In addition, some interesting two-regime and three-regime data sets are observed, again hypothesized to be a data collection phenomenon not a property of the traffic flow itself. Further analysis is required to determine the effect of HOV lanes and how they should be treated in the macroscopic flow model. For example, if the HOV typically carries one-third of the average volume of another regular lane, should it be represented as increased lane capacity of one-third? The problem with that approach is that given larger traffic volume than typically encountered in the data, the true capacity of the HOV lane is much higher than one-third. In this case, the “real” freeway can accommodate higher flows, but the model predicts that the freeway is limited by the one-third assumption of HOV lane inclusion. At present, the simulation model built for the test location does not include HOV lanes (i.e. all sections have just three lanes). Further analysis is required to determine how to process the data available from ADOT to address the inclusion of HOV volume as well as what to do with the data when there are missing or intermittently-working detectors at a particular station (or having the entire station non-reporting).

As such, conclusions about the spatial variability of the speed-volume characteristic cannot be made from the available data, since either computing the total or the average volume and/or speed is corrupted by the missing detector counts. The MILOS software was modified to accept variation in the speed-volume characteristic by location, but without reliable speed-volume data, this feature has not been exercised.

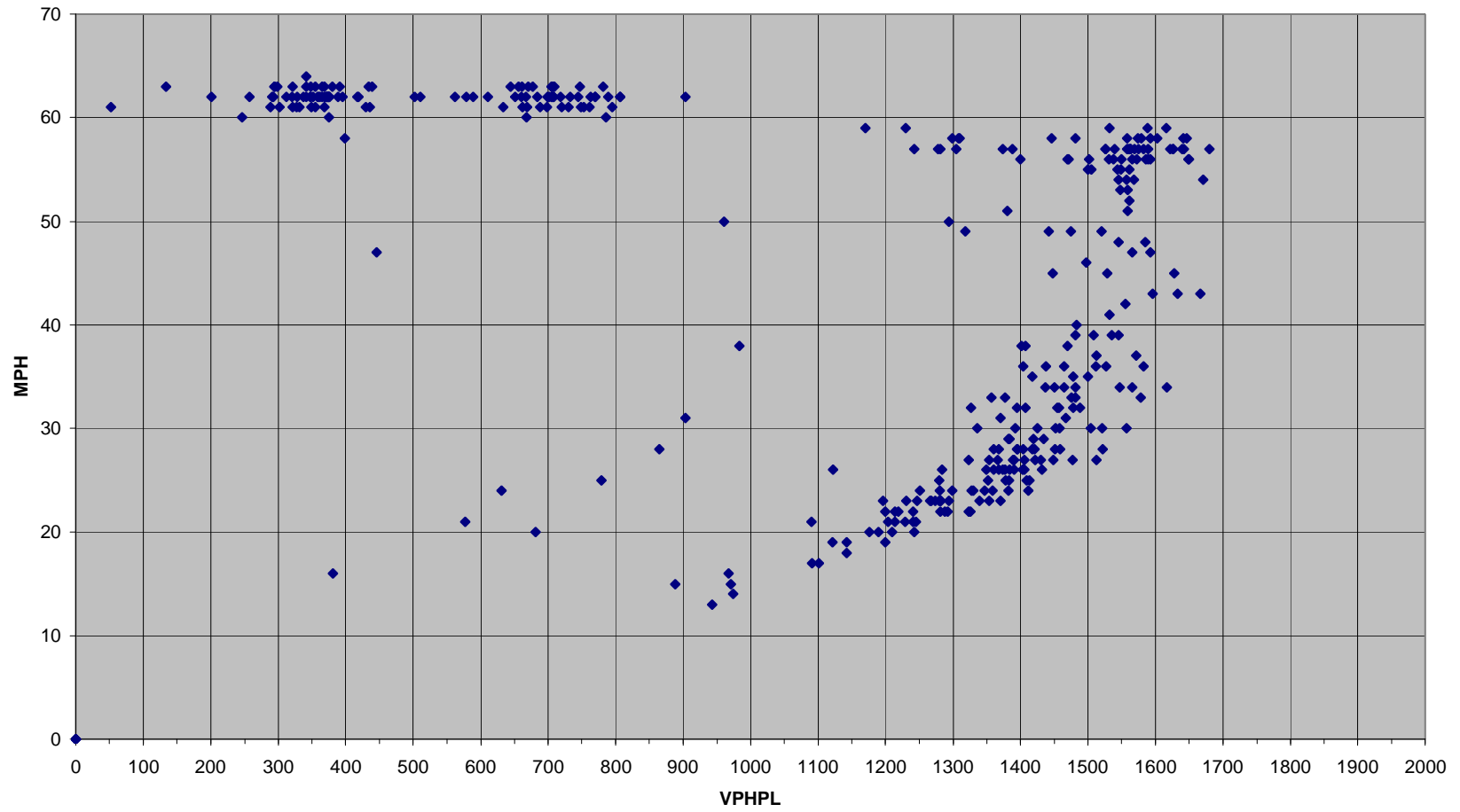

Figure 4 - Example of Speed/Volume Data I-10 at 58th Avenue for all of 1999 from 7:45-8:00 AM

3.3.3 Long Scenario

MILOS' performance was tested in simulation using a detailed traffic scenario that represented a full "morning rush" period, representing the 5 AM to 11 AM period. Higher-fidelity (one-minute count) data was obtained from ADOT, and on-ramp and off-ramp differences were used to compute on-ramp volumes and off-ramp turning probabilities (volumes). Because of unreliable detectors and detector stations, developing this scenario from the data was complex. For example, the May 2000 data did not include data from the on-ramps because the on-ramp detectors were not reporting any data at that time. To remedy this, additional data from October 1999 was used, when the on-ramp detectors were operating. There was no data available for off-ramp volumes, so they were estimated from the May 2000 data.

This scenario construction exercise created average traffic volumes arriving from each of the on-ramps and the average upstream flow, changing every 15 minutes. In running the simulation, these average volumes are used, with random fluctuations around the average used to vary the number of vehicles entering the simulated freeway each simulated time step. Based on this data analysis, Table 3 shows the average volume of traffic entering the freeway model heading east at 83rd Avenue, with the average changing at 15 minute time intervals. Table 4 & Table 5 show the average on-ramp volumes at each of the on-ramps from 83rd Avenue to 35th Avenue, again with changes in the average flow occurring every 15 minutes.

**Table 3 - Long Scenario Upstream Volumes Entering I-10 Simulation
at 83rd Avenue (VPH)**

	:00 - :15	:15 - :30	:30 - :45	:45 - :00
5:00 AM	2925	3350	3775	4200
6:00 AM	4500	4500	4500	4500
7:00 AM	4500	4500	4300	4100
8:00 AM	3900	3700	3500	3300
9:00 AM	3100	3100	3100	3100
10:00 AM	3100	3100	3100	3100

**Table 4 - Long Scenario Average On-Ramp Volumes
Every 15 Minutes (5 AM To 8 AM, VPH)**

	5:00	5:15	5:30	5:45	6:00	6:15	6:30	6:45	7:00	7:15	7:30	7:45
83 rd	500	500	500	500	500	500	500	500	500	500	500	500
75 th	550	750	750	750	750	750	750	750	1000	1000	1000	1000
67 th	200	175	175	175	175	175	175	175	175	175	150	150
59 th	375	375	375	375	375	375	375	375	375	375	375	375
51 st	450	450	450	450	450	450	450	450	450	450	450	450
43 rd	350	350	350	350	350	350	350	350	350	350	350	350
35 th	600	600	600	600	600	600	600	600	600	600	600	600

**Table 5 - Long Scenario Average On-Ramp Volumes
Every 15 Minutes (8 AM To 11 AM, VPH)**

	8:00	8:15	8:30	8:45	9:00	9:15	9:30	9:45	10:00	10:15	10:30	10:45
83 rd	500	500	500	500	500	500	500	500	500	500	550	550
75 th	700	700	700	700	700	700	700	700	600	600	600	600
67 th	140	140	140	140	140	140	140	140	140	140	140	140
59 th	300	300	300	300	225	225	225	225	125	125	125	125
51 st	450	450	450	450	450	450	450	450	450	450	450	450
43 rd	350	350	350	350	200	200	200	200	200	200	200	200
35 th	450	450	350	450	450	450	450	450	450	450	450	450

3.3.4 Simulation Results from Long Scenario

Table 3 shows that the highest volumes enter the freeway from upstream between 6 AM and 7:30 AM. Tables 4 and 5 show that the highest on-ramp volumes come from 75th Avenue between 7 AM and 8 AM. The simulator essentially processes these upstream and on-ramp flows, and creates a realistic picture of congestion on the freeway and queuing at the ramps as a result of the congestion.

3.3.4.1 Simulation Results with No Control

First, the long scenario was run with no control on the ramps (ramp meters off) Figure 5 shows the time-space-density diagram, Figure 6 shows the actual on-ramp flows; and Figure 7 shows the queue lengths. Figure 5 shows congestion beginning around time 150 minutes (7:20 AM) near 35th Avenue, and propagating upstream from that time forward. (Note: The distance marker of "0" is where vehicles enter the model at 83rd Avenue.) The congestion becomes very significant near 59th Avenue by 250 minutes into the simulation run (8:50 AM). There is significant queuing at the 67th Avenue ramp at this time because of the interruption in the flow on the freeway. This congestion persists through the end of the simulation at 11 AM. Note that in the simulation, vehicles do not divert once the queues reach the storage limits on the ramps, as they would in reality. From Figure 7 it is clear that the queues are dissipated by the end of the simulation run, although there are still significant number of vehicles "parked" in the congestion on the freeway.

These results represent the baseline response of the freeway system to the "long scenario" flows. They represent a "typical" morning rush hour, with no ramp metering control. The freeway flow breaks down completely, with vehicles backing onto the 67th Avenue onramp because of the blocked freeway. The next two sections show how the freeway system can respond using two different ramp-metering strategies.

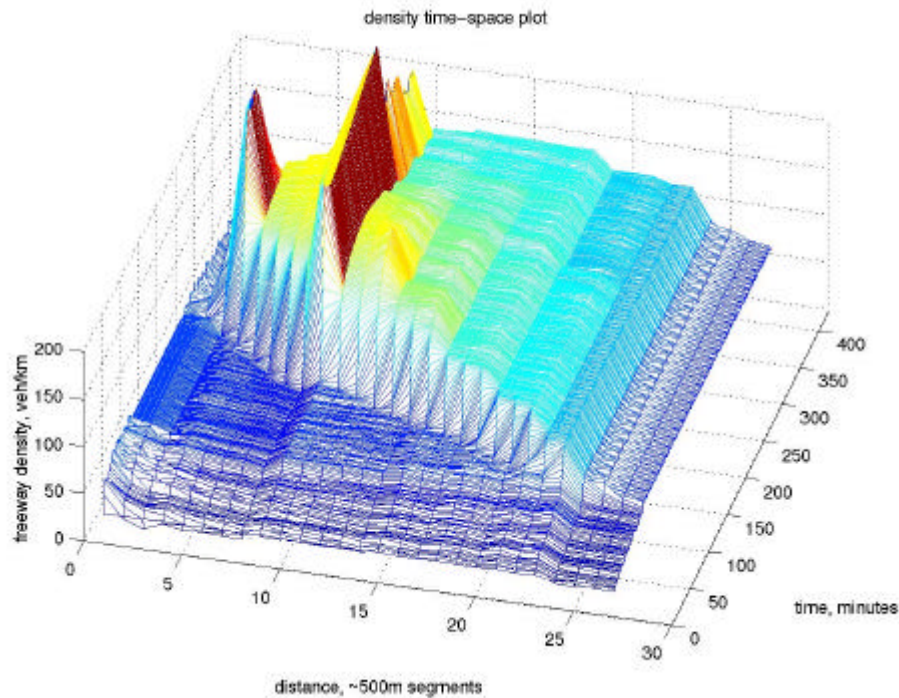

Figure 5 - Density With No Ramp Control

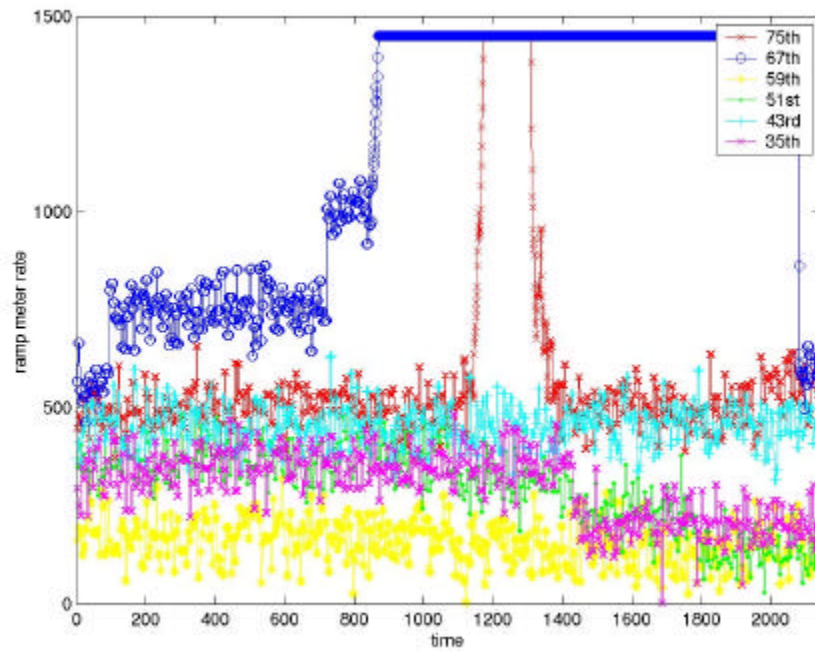

Figure 6 - On Ramp Flows (VPH) With No Control

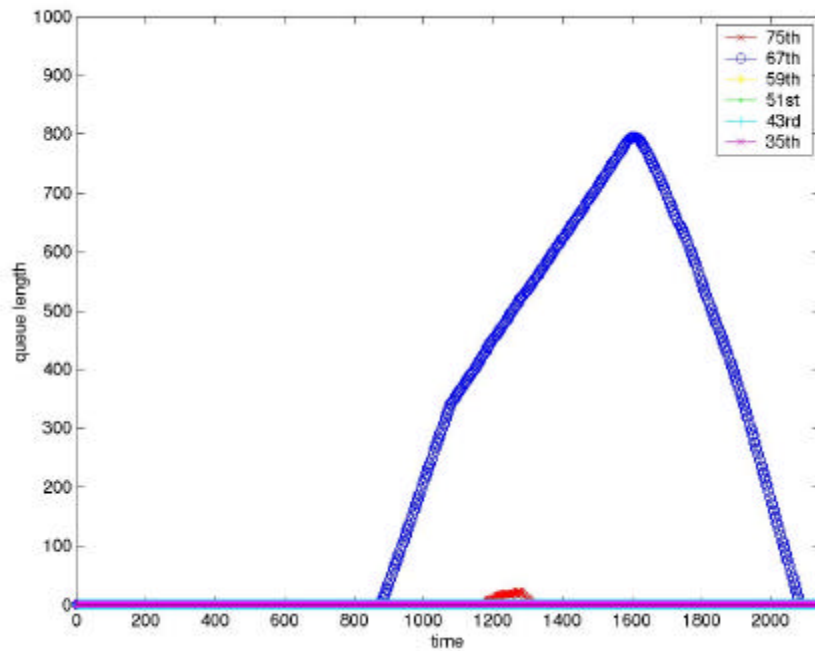

Figure 7 - Queues With No Control

3.3.4.2 Simulation Results with Traffic Responsive Metering

For a comparison, the long scenario was also run using the traffic responsive volume/speed metering with queue management policy, described in Section 3.2. Figure 8, Figure 9 and Figure 10 show the results. It is clear that this strategy has not improved the flow significantly in the long scenario, with the congestion shown in Figure 8 building in a pattern similar to the no-control case. Although this strategy does attempt to limit the flow onto the freeway via metering, it is unsuccessful in avoiding congestion because of avoiding the building of large queues. This strategy "opens up" the ramps when the queues reach the storage limits of the ramp. This behavior can be seen with the changes in the metering rates shown in Figure 9, when compared with the queues shown in Figure 10. For example, this strategy starts building queues at 75th and 67th Avenues when the on-ramp flows start to increase, but when these queues become too large, the metering rates are allowed to increase. This stops the growth of the queues, but also begins to release the stored vehicles onto the freeway, making the already building congestion worse.

Although this approach does respond to traffic conditions local to each ramp, it fails in the objective of improving overall freeway flow. Its focus on local ramp conditions does not seem to provide enough information for improving freeway-wide flow.

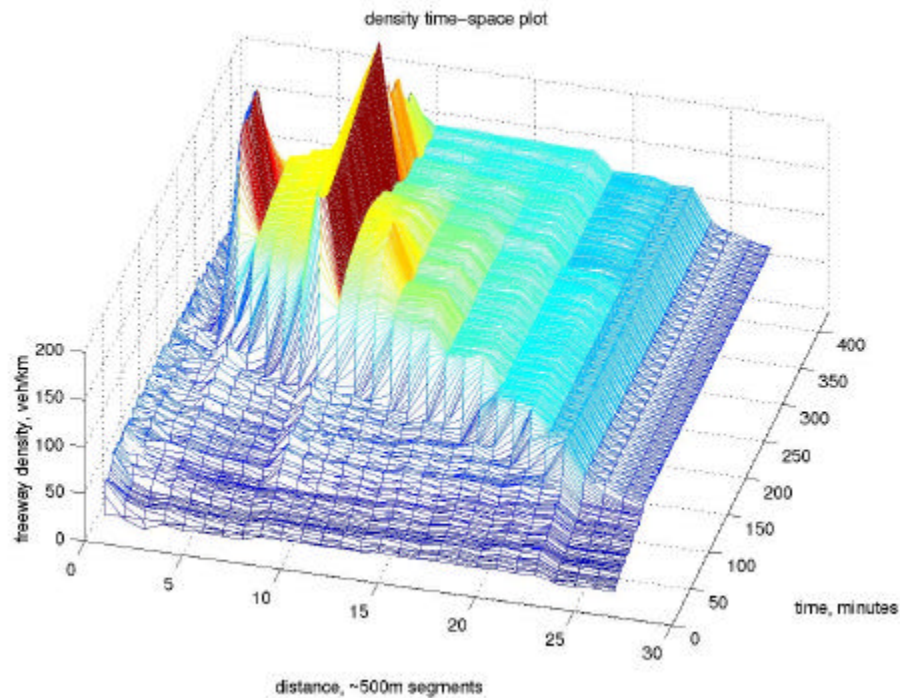

Figure 8 - Density With Traffic Responsive With Queue Management Control

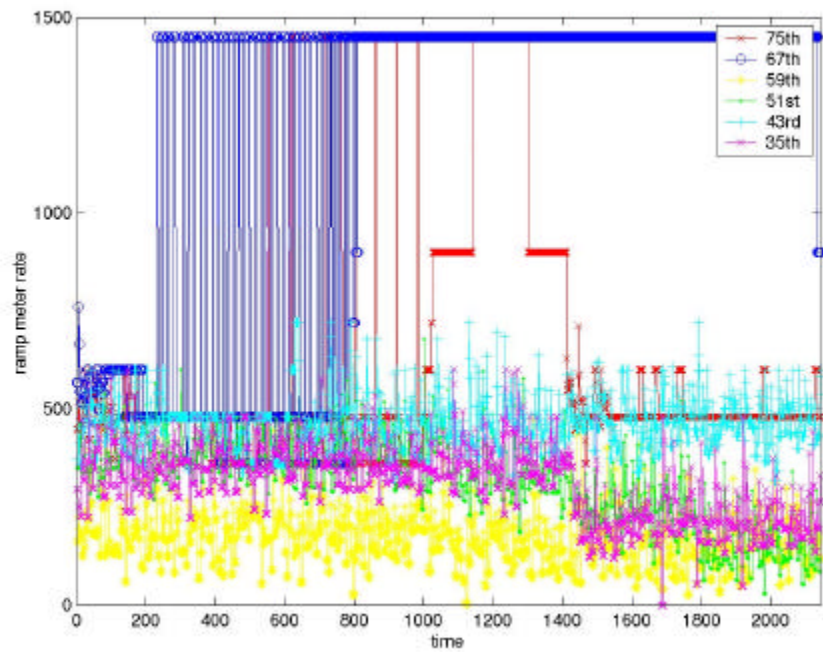

Figure 9 - Metering Rates (VPH) With Traffic Responsive With Queue Management Control

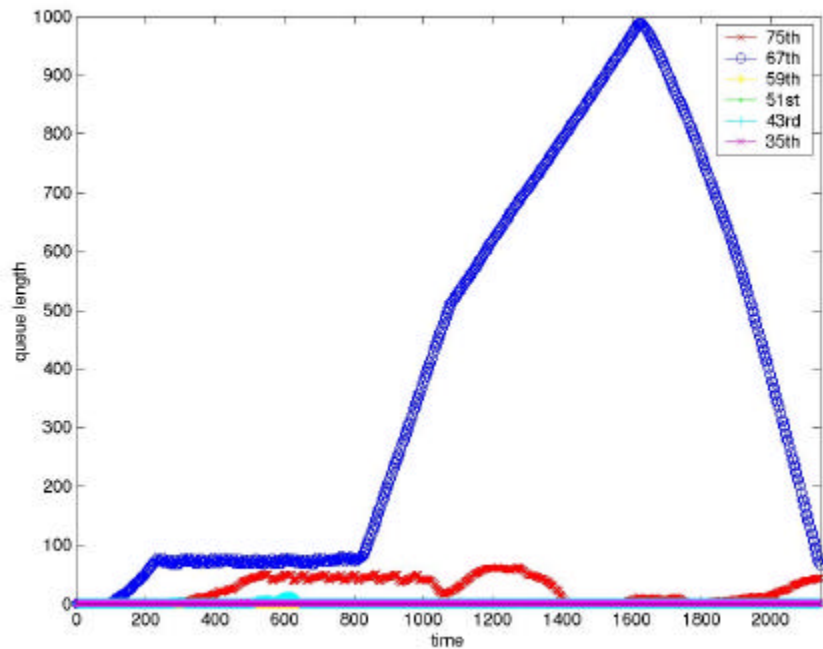

Figure 10 - Queues With Traffic Responsive With Queue Management Control

3.3.4.3 Simulation Results using MILOS Control

Finally, the long scenario was run with MILOS controlling the ramps. Figure 11, Figure 12 and Figure 13 show the results. With MILOS control, the severe congestion of the no-control case is essentially eliminated, as seen from the densities in Figure 11. This is accomplished through active changing of the metering rates, as shown in Figure 12. MILOS achieves this improvement in freeway flow by creating significant queues, as shown in Figure 13.

There is no significant building of congestion throughout the morning rush-hour period. This is a marked contrast to the no-control and traffic-responsive cases. The MILOS hierarchical control imposes the maintenance of freeway flow as a constraint. The area-wide controller allocates the resulting queue growth across all of the ramps, resulting in the uniform queue growth that is visible in Figure 13. The local PC-RT controller will take advantage of short-term opportunities to release more vehicles to the freeway, but within the constraints set by the area-wide controller. At 67th Avenue, Figure 13 shows short periods of queue growth followed by short periods of queue dissipation, as MILOS actively manages the queue.

Rather than storing all of the queued vehicles at one ramp, MILOS succeeds in using all of the ramps to store vehicles and maintain the most efficient use of the freeway.

The graphs in Figure 14 summarize the overall freeway performance statistics for the three cases. MILOS is able to keep freeway speeds highest on average of the three cases. With MILOS control, the throughput is also the highest, with throughput defined to be the fraction of vehicles entering the simulation that have left at 11 AM. Although total queuing time for MILOS is largest, the total travel time for vehicles in the simulation is significantly smaller. The total travel time includes queuing time at the ramps as well as travel time through the freeway. The traffic-responsive strategy actually performs worse than the no-control case in throughput, total travel time and queuing time. This is most likely due to the fact that this strategy allows queues to build at first, potentially keeping the freeway flowing. But just as traffic on the freeway begins to build, it begins releasing the stored vehicles onto the freeway because the queue storage limits are reached. This essentially stores vehicles from the earlier part of the morning, and releases them just as congestion really starts to build, exacerbating the congestion. The traffic-responsive strategy also is not optimized for this particular situation.

Because MILOS maintains the freeway flow at the cost of queue growth, it has more total queuing time than the no-control case. Notice that MILOS is able to allocate the queue growth to all of the on-ramps, and in the process maintain the flow on the freeway. Because MILOS stores vehicles on the ramps, rather than on the freeway, the overall travel time for all vehicles is smaller.

Attempts to penalize queue growth more heavily using the parameters in MILOS, at the expense of increased congestion, did not lead to significantly different results. Further experiments could explore this trade-off more carefully with the current software.

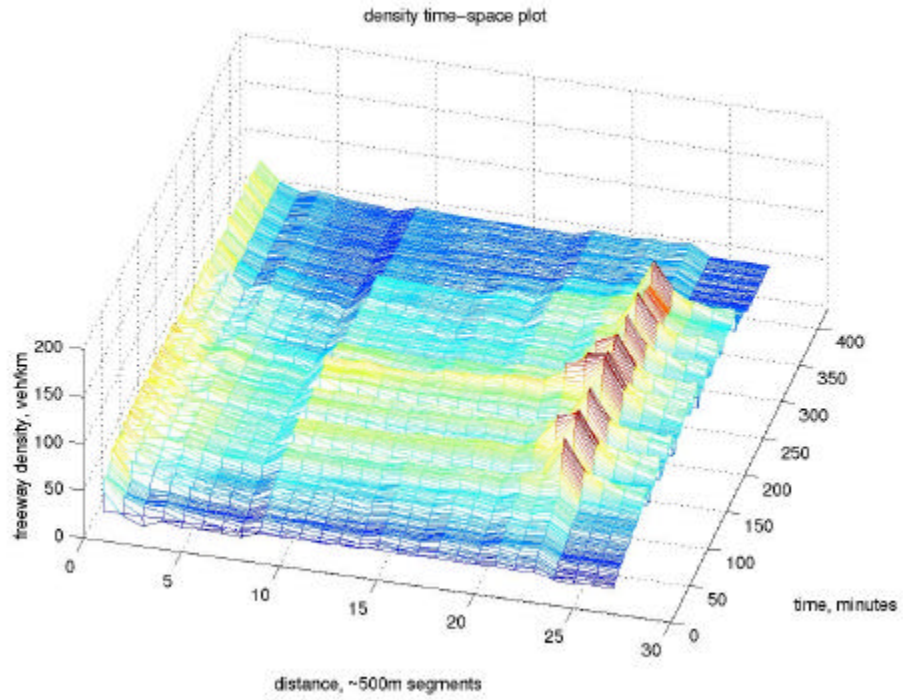

Figure 11 - Density With MILOS Control

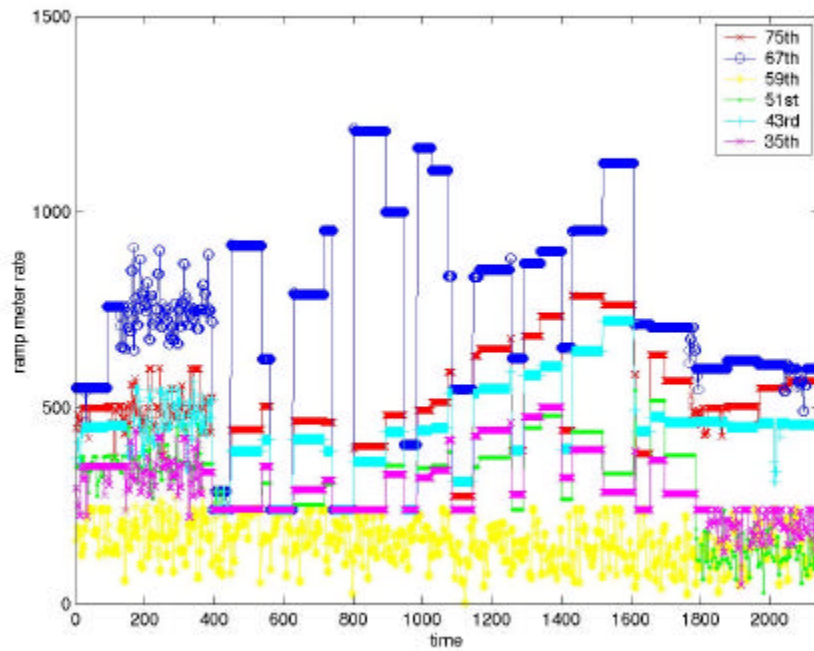

Figure 12 - Metering Rates (VPH) With MILOS Control

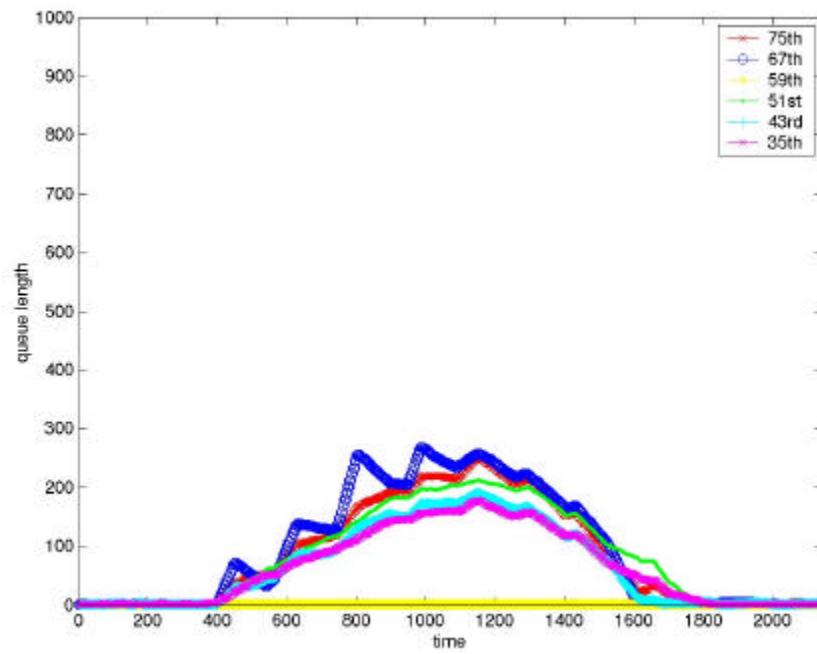

Figure 13 - Ramp Queues With MILOS Control

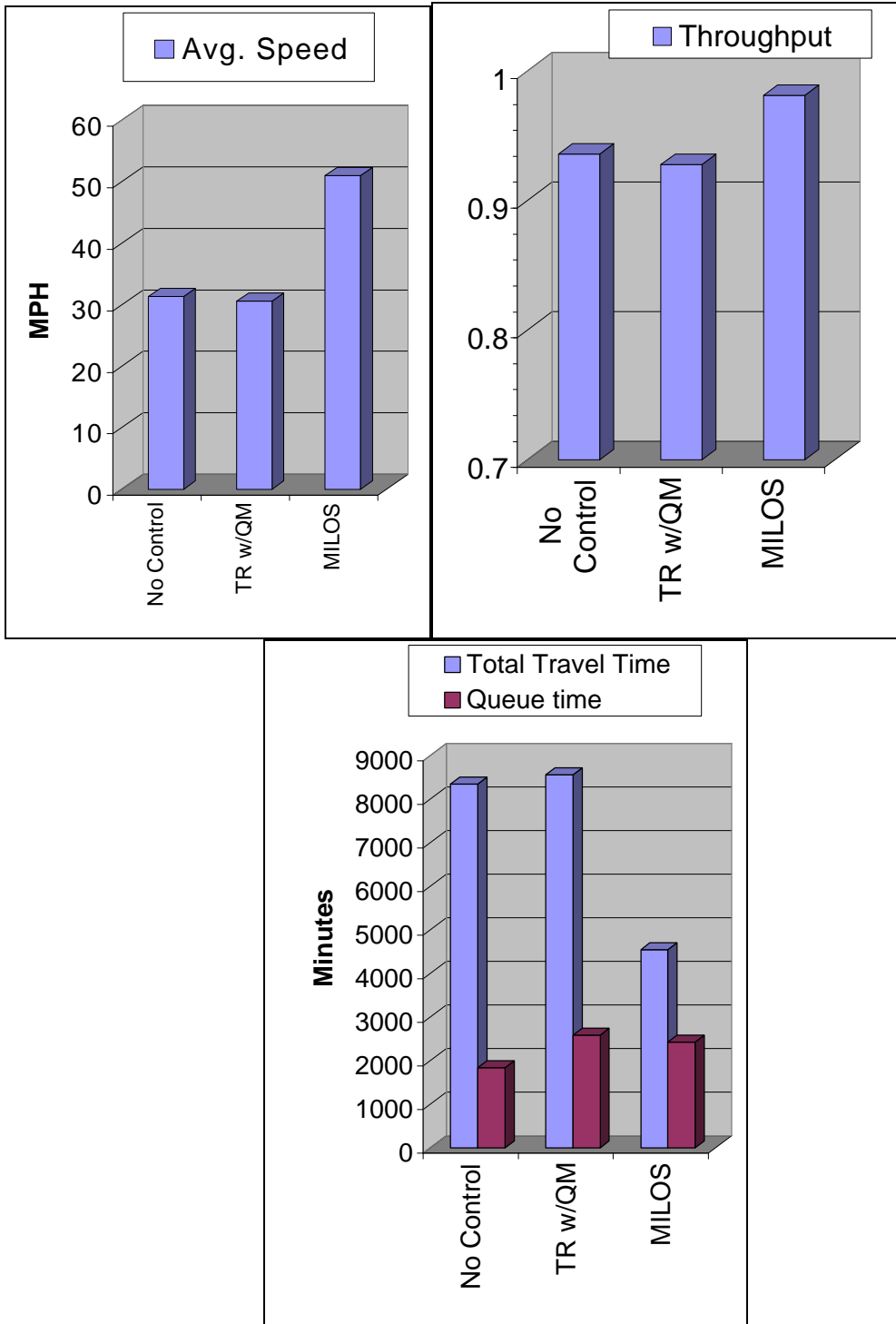

Figure 14 - Summary of Performance I-10 Simulation Results

4 INTERFACE DEVELOPMENT

The MILOS architecture is an optimization based control framework. Parameter estimation, especially turning probabilities, freeway detector data collection/filtering, incident detection and surface-street performance all are required inputs to the MILOS control hierarchy. In particular, MILOS requires real-time turning probabilities, demand flows, green splits, and queue lengths from the interchange control system.

The MILOS hierarchical control algorithms were developed in the MATLAB environment. The components of the MILOS software in MATLAB include the area-wide controller, the PC-RT rate regulator, the macroscopic freeway simulator and supporting code. To solve optimization problems as part of the control hierarchy, MILOS makes calls to the CPLEX optimizer. To support real-time data, MILOS interfaces with ADOT's FMS software. The diagram in Figure 15 sketches the primary software interactions. The following sections summarize each of these interactions, and describe the current state of the development of these software interfaces.

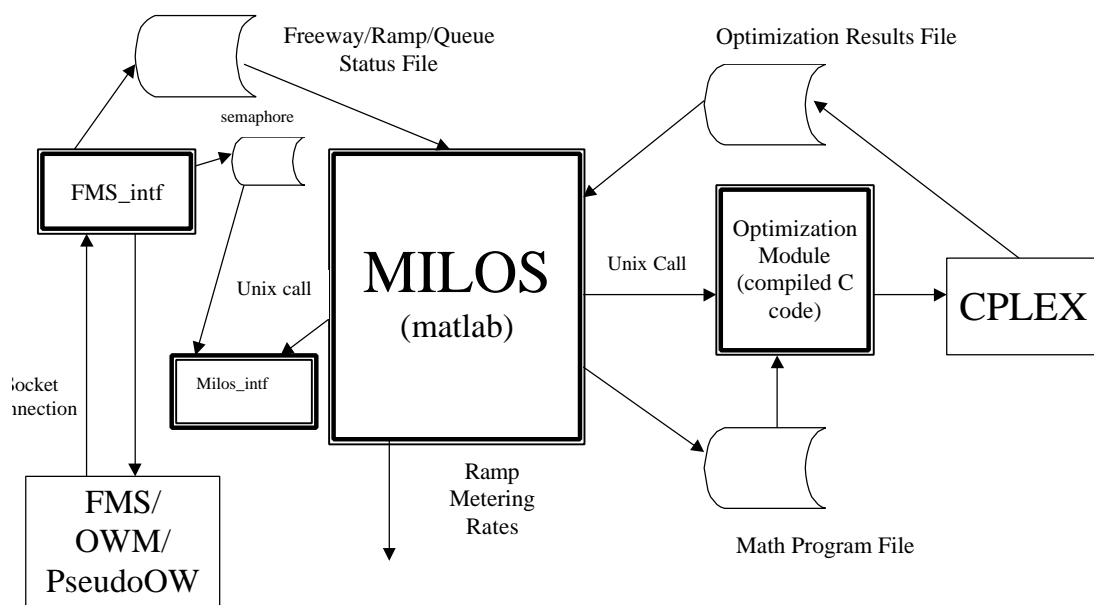

Figure 15 - MILOS Software Interactions

The area wide coordinator calls CPLEX to solve a quadratic program, and the PC-RT controller calls CPLEX to solve a linear program. This is accomplished through a UNIX call from matlab to compiled C modules that operate on matlab-generated math program files. These math program files describe the optimization problems being solved by the area-wide coordinator or PC-RT controller.

4.1 FREEWAY REAL-TIME DATA INTERFACE

In order to run using all of its capabilities, MILOS requires real-time input from the freeway, the ramps and the adjacent interchanges. It must also send commands controlling the ramp metering rates to the ramp meter controllers in the field. The current project investigated the technology to create both of these interfaces (input from field to MILOS, output from MILOS to ramp meters).

The current project was able to use existing software to collect some of the needed input data from the field. Data on freeway speeds and volumes are available from the existing FMS. This information was used, both in a recorded, pseudo-real-time test of the interface concept, and in archived form to assist in simulation calibration. The FMS system was initially designed to include information from the adjacent traffic intersections, but this part of the system was not implemented. Because of this, traffic intersection phase status and queues were not available from the real-time system. Section 4.2.1 describes a test of concept for such an interface to the traffic intersection information based on a simulation model.

Creating an interface to send commands from MILOS to the ramp meters was explored through a subcontract, but was not possible within the current project budget. Because of this, the interface to the ramp meters was not developed. Consequently, all results in the test showing the effectiveness of MILOS are limited to experiments with simulation, as described in Section 3.3.4. MILOS produces metering rates, but the delivery of these rates to the field still requires software development.

The following sections describe the details of the connection between field data from the FMS and MILOS.

4.1.1 Connecting with FMS

ADOT supplied a “Recorder” executable in order to simulate connecting to real time data through a socket connection with their FMS server. To run this program, a file called `FMS_config` will have to be changed as follows:

1. Change all references to “mustang” to the system you are using.
2. In the entry called “Router” there is the name of the file containing the recorded data; change to name of file you are using.

To run this program, type the following at the UNIX prompt:

```
./FMS_Router %MILOS_DATAGRABBER -d -f
```

A routine `FMS_client.c` was supplied by ADOT to connect up with this server. This routine should be linked in with the `FMS_intf` routine.

4.1.2 Real Time Data Conversion

A routine `FMS_intf.c` was written to interface with `FMS_Router`. This routine will:

1. Create a semaphore to aid in interfacing with MILOS.
2. Synch up with `FMS_Router` by reading a socket returned from `FMS_client` and continue reading until a record of size 32 words is read. This will be the header portion of a FMS record.

3. Read records from the socket until the header indicates that an OWM_FWYSEGMENT_STATUS_MSG has been read.
4. Call the routine that will decode this message for MILOS.

This routine is compiled using the following command:

```
gcc FMS_intf.c FMS_Client.c -l socket -l nsl -oF.out
```

4.2 MILOS INTERACTION WITH REAL-TIME DATA

Hooks have been placed in the MATLAB program to read real time data instead of simulated data. These hooks will call `getrealtime_15min`, `get_realtime_demands` or `get_realtime_data`. Each of these routines will call `milos_intf`, which will wait for the semaphore to be signaled and then return control back to the MATLAB program. At this time the above routines will read the record as indicated in Table 6. In Table 6, column 1 refers to the routine called, column 2 refers to the file read and column 3 refers to the MATLAB matrix that is updated. The file read will be read as a MATLAB vector

Table 6 - Real Time Files Read by MATLAB

Routine	File(s) Read	Structure Updated
<code>getrealtime_15min</code>	<code>onramp_real</code> <code>offramp_real</code> <code>upstream_real</code>	
<code>get_realtime_demands</code>	<code>demands_real</code>	
<code>get_realime_data</code>	<code>vol_real</code> <code>density_real</code> <code>speed_real</code> <code>queues_real</code> <code>onramp_real</code>	

These real time files read by MATLAB are formed using the data from `FMS_Router` as indicated in Table 7.

Table 7 - Formation of Real Time Files

File	FMS structure	Structure element	Detector #(s)	Processing
onramp_real	owm_fwysegment_status_t	Vph	2, 14, 20, 25, 30, 68 and 75	The field will be the average of the 2-minute data over a 15-minute period. This data should be element 7 of the fwdlanes array. However, this data did not appear in any of the data looked out
offramp_real	owm_fwysegment_status_t	Vph	12, 18, 23, 34, 72 and 80	The field will be the average of the 2-minute data over a 15-minute period. This data should be element 7 of the fwdlanes array. However, this data did not appear in any of the data looked out
upstream_real	owm_fwysegment_status_t	Vph	2	The field will be the average of the 2 minute data over a 15 minute period
demands_real	owm_fwysegment_status_t	Vph	14, 20, 25, 30, 68 and 75	This data should be element 7 of the fwdlanes array. However, this data did not appear in any of the data looked out
vol_real	owm_fwysegment_status_t	Vph	2, 5, 6, 8, 10, 12, 14, 16, 18, 20, 22, 23, 25, 26, 28, 30, 32, 34, 68, 71, 72, 133, 136, 75, 77, 79 and 80	
density_real				Calculated using vol_real and density_real
speed_real	owm_fwysegment_status_t	speed_average	2, 5, 6, 8, 10, 12, 14, 16, 18, 20, 22, 23, 25, 26, 28, 30, 32, 34, 68, 71, 72, 133, 136, 75, 77, 79 and 80	
queues_real	owm_tisc_snapshot_t			Not available at this time
onramp_real	owm_fwysegment_status_t	vph	14, 20, 25, 30, 68 and 75	

4.2.1 Traffic Interchange Interactions

To achieve the maximum benefits from MILOS, the status of the traffic intersections adjacent to each ramp is required. In the design of MILOS, this information is used to "look-ahead" and helps predict the rate of queue growth or dissipation at the ramp. The current phase and detector information at the intersection allows MILOS to more accurately estimate the rate of arrivals to the ramp. In the current FMS, traffic interchange information is unavailable. The current project only developed interfaces to the FMS system. Interfaces with other systems to obtain the traffic intersection data were not within the scope or budget of the current project.

To demonstrate the concept of how the traffic intersection information would be used with MILOS, a CORSIM model of an interchange was used. Changes in queues at a ramp were computed using detector and phase information extracted from the CORSIM model. The CORSIM model interfaces with the queue estimation procedure through a .DLL written in C++. The CORSIM model and interface procedure leverages technology developed for the Tempe RHODES project

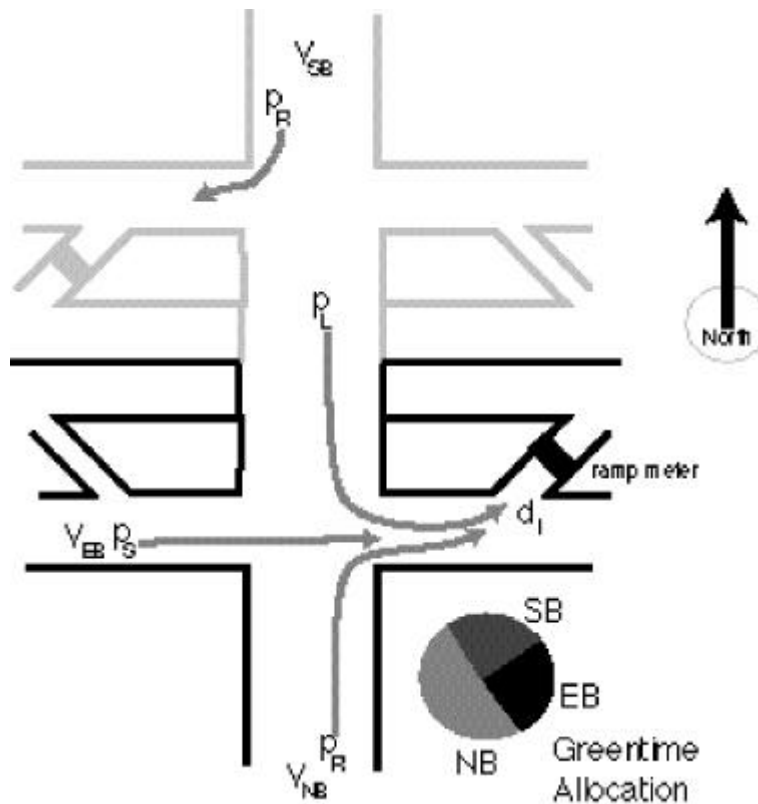

Figure 16 - Sources of traffic intersection demand for a ramp

The MILOS DLL is written in VC++ and calculates the volume of cars and the rate of cars entering the ramp of the interchange model in CORSIM. The DLL is called by CORSIM every time step of the CORSIM simulation. However, the calculation of volume and rate is done once every MILOS_INTERVAL

time step that is embedded in the DLL. The reason for this is that the MILOS model that uses real time data wants the details only after a fixed time interval that is different from that of CORSIM. To bring in this nature of the real time requirements the DLL has been programmed accordingly.

CORSIM has run time extensions that are used to invoke the DLL's. The CORSIM Traffic Tool has to be configured to run the DLL. Figure 17 shows the information flow in the interactions between the CORSIM interchange model and the MILOS DLL, as described below:

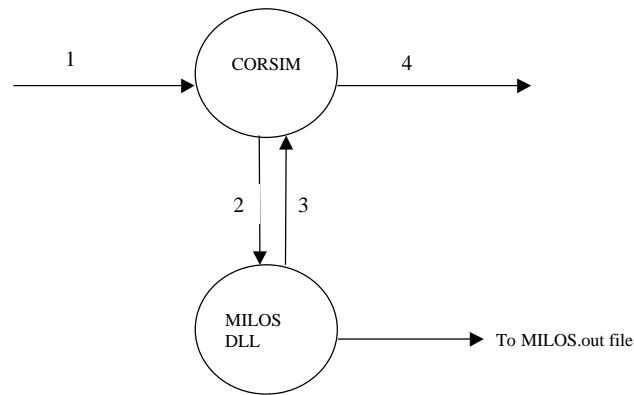

Figure 17 - Sequence of MILOS traffic intersection DLL interactions

1. CORSIM is run with the interchange input file, using the MILOS tool configured to invoke the MILOS DLL at run time.
2. When CORSIM finds that it has a run time extension in its input file, at the appropriate time, it hands control to the MILOS DLL. Now MILOS DLL has control.
3. MILOS DLL executes its code. It has access to all of the CORSIM data structures, including detector counts. It does all the ramp calculations and stores them onto a file MILOS.out. After the calculations are complete, it hands over control back to CORSIM, which resumes from where it left.
4. Once the simulation is over the MILOS.out file and the usual CORSIM output file are generated.

Note: Steps 2 and 3 occur continuously throughout the entire run of the simulation. Step 4 only occurs at the end of the simulation run.

The Milos DLL has been programmed in such a way that it is easy to plug in real time data in place of the CORSIM module at a later stage. The program right now uses two levels of abstraction. One that is more generic and could be used for the real time data and the other that is CORSIM specific. The generic abstraction makes the plugging in of real time modules easier at a later stage. The CORSIM specific functions are invoked by the generic ones. As shown in Figure 18, the CORSIM specific modules need only be replaced when translating the procedures for real-time calculations. For example, this .dll could be invoked in real-time by MILOS to compute the changes in queue lengths as a result of activity at the interchange.

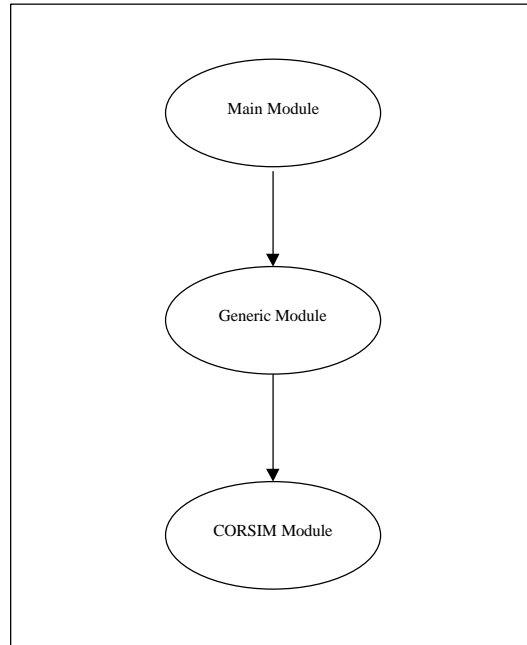

Figure 18 - Abstraction Levels for Traffic Interchange Software

To run the MILOS.DLL, follow the steps below:

1. Open the file MILOS.mdp in VC++ and compile the program.
2. Once this is done run CORSIM Simulation on the input file using the MILOS option in the TSIS Tool - Simulation menu.
3. The Simulation generates two files MILOS.out and MILOS1.out that contains the Ramp Details that has been calculated by the MILOS.DLL.

4.2.2 MILOS.out

This is the output file that is generated by the queue estimation program. This file has easy readability as all values printed have a description of what they are. It contains the following details.

- Number Of Cars Onto The Ramp Coming From The Left.
- Number Of Cars Onto The Ramp Coming From The Right.
- Number Of Cars Onto The Ramp Coming Straight Through.
- Total Number Of Cars Onto The Ramp.
- Rate Of Entry Of Cars Onto The Ramp For The Last Time Interval
- Rate Of Entry Of Cars Onto The Ramp For The Last Three Time Interval

An example of the MILOS.out output file is found in the Appendix.

The MILOS1.out file is similar to the MILOS.out file except that it just has all the data without any descriptions of what they stand for. Each line in this file stands for each MILOS interval. The data are printed in the same order as that in the MILOS.out file.

5 CONCLUSIONS

5.1 RESEARCH CONTRIBUTIONS

The following list highlights the major contributions of this MILOS research project:

- Created a macroscopic simulation model of the I-10 freeway. In this process, a methodology was developed for using freeway flow data from the FMS archives and tailoring it to the form for the simulation model.
- Demonstrated potential effectiveness of MILOS in significantly decreasing freeway congestion due to merging on-ramp traffic. Tests in the field will be required to show how these simulation results translate to actual performance.
- In the simulation tests, demonstrated evidence of the superiority of coordinated MILOS strategy to independent metering at each ramp. MILOS can achieve this at the cost of building significant ramp queues during times of heavy on-ramp flows. In the simulation experiments, these queues were distributed across all of the ramps being controlled. Together with the earlier simulation experiments for SR202, MILOS has now been shown to be consistently effective in these simulation tests.
- Several students, both undergraduate and graduate, were involved with this development and integration effort, and gained valuable experience in the software issues of a hierarchical, real-time transportation system.

5.2 FUTURE RESEARCH ISSUES

Some significant obstacles to testing MILOS in the field remain. Many of these are integration-related issues:

- Unreliable data from the detectors led to difficulty in estimating necessary freeway parameters. Although this is inconvenient and made the data analysis task more time consuming the project was able to make necessary adjustments and approximations in estimating parameters off-line. In the end this didn't, in our opinion, seriously affect the study results.
- Unreliable data from the detectors will make it very difficult to deploy the system in real-time. Reacting to freeway data that is reliable only a fraction of the time is a serious burden for any ramp metering strategy. Especially for a coordinated ramp metering system that tries to adjust metering rates along a corridor, "holes" in the data will seriously degrade the system's effectiveness. It is estimated that MILOS can be effective with less than 90% detector reliability. It is unlikely for MILOS to be effective with less than 50% detector reliability.
- In this project, FMS system outputs were never decoded reliably to be able to read FMS messages and extract volumes/speeds, etc. It was difficult to localize problems to the project software, versus when

they were a result a detector station failure. In the future, working closely with someone intimately familiar with the details of the FMS software should make this interaction between MILOS and the FMS real-time data more reliable.

- In order to implement coordinated ramp metering in the field with the current FMS, an interface is required that allows ramp-metering rates to be communicated from a central location to the individual metering station controllers. For example, MILOS could reside on a workstation in a central location (such as the TOC) and then be communicated via the FMS to the field. This centralized, automated updating of ramp metering rates should be available on a time scale such as every few minutes. Because developing this interface was not feasible within the budget of this current research project, the project only tested the MILOS system on the I-10 freeway through a simulation based on real ADOT traffic data.
- Queue length estimation should be integrated in the MILOS software. Appropriate experiments using the queue length estimates are also needed to determine the required accuracy of these queue estimates. Poor estimates could lead to poor performance by MILOS. Currently, the I-10 simulation passes perfect information about the queues to the optimization procedures. In practice in the field, such perfect queue length information is not possible.

APPENDIX A

DESCRIPTION OF MATLAB SOFTWARE

MILOS is implemented in MATLAB as a set of 34 M-files, and approximately 20 supporting M-files that are not essential to running the simulation. Each of these 34 M-files is listed in the table below, with a one-line description of its top-level functionality. More detailed comments are embedded in the code itself.

Name of .M File	Short Description
Apply_next_rate	Given the measured demand at the ramp and upstream on the freeway, locate the correct ramp metering rate in the PC-RT solution table and send it to the meter
Check_steady	A statistics processing support function which determines when the freeway has returned to “nominal” congestion conditions. Used for reporting the time after congestion clearing.
Compute_segments	Given the definition of the section lengths and the nominal section length, determine how many sections are in each segment.
Get_nominals	From the volumes predicted in each section by AWCOP, retrieve the set-points of density and speed for each section
Get_ODetc	Retrieve the turning probability and demand matrices from the MATLAB workspace and synthesize the OD matrix from the turning probabilities
Getmaxvol	Find the maximum volume limitation in a section from the speed-density relationship
Initialize_vars	Initializes most of the internal arrays, statistical counter variables
Linearize	Gets the linear formula for a nonlinear equation around a set point
Make_lowprob	Writes a lower-level PC-RT sub-problem to a text file for reading into CPLEX for solution
MakeQP	Writes the upper-level AWCOP to a text file for reading into CPLEX for solution
MakeLP	Writes an upper-level linear AWCOP to a text file for reading into CPLEX for solution (for comparison of MILOS to other ramp metering control methods)
Make_solve_lowprobs	Wrapper loop that iterates through all of the lower-level PC-RT prediction combinations, solves the problems using CPLEX, and stores the solution for the next time period in a matrix of “next rates”
Mesh_fwy_NEW	Set of graphics calls to display the results of the simulation, tailored to the I-10 scenario
Modfwy2	The macroscopic freeway flow model
Monitor	Identifies the points within the freeway flow and on-ramp demands when the trend of the volume is exceeding the SPC inner or outer control bands. Explicitly finds the locations one-minute upstream (based on current estimate of travel time) of each ramp location.
Network_setup	Identifies the physical and geometric parameters of the study location
Ramp_meter	Applies the ramp metering method being used. Allows no control, ADOT feedback control, ADOT feedback control with queue control, Area-wide LP, and MILOS
Reopt_overcap	Identifies the time when the freeway at some location has transitioned to congested conditions and re-solves the AWCOP with a capacity limitation in the congested section (or sections)
Reopt_QP	Re-optimizes the QP for new target ramp metering rates and target freeway flows when the SPC monitor function identifies a drift in one of the critical

	variables
RunI10_new	Runs the simulation for one iteration
RunsimI10	Runs the simulation for multiple iterations to get statistics of performance. Establishes a number of global parameters, such as which control method to use, how many time periods to run, etc.
Set_parameters	Translates one listing of macroscopic model parameters into another array of parameters with additional parameters. A confusing addition to the software, this conversion from one array to another should be modified within the code at some point
Setup_lowprob	Establishes some data (e.g. predictions of demand flows) to be used in “making” the low problem with make_lowprob
SolveI10lp	Calls CPLEX and retrieves the solution variables for a lower-level PC-RT optimization problem
SolveLP	Calls CPLEX and retrieves the solution variables for an upper-level linear AWCOP
SolveQP	Calls CPLEX and retrieves the solution variables for an upper-level MILOS quadratic AWCOP
Speed_dens_char	Implements the speed-density relationship used in the macroscopic flow model
Speed_deriv	Implements the derivative of the speed-density characteristic used in the macroscopic flow model (in the PC-RT formulation)
Study_settings	Establishes a number of variable parameters that affect performance of the simulation and the optimization process, such as the weighting values on each surface-street interchange congestion, weighting values for freeway segment congestion, minimum and maximum metering rates, when MILOS should be allowed to run during the simulation, etc.
Threshold	Applies an exponential function to restrict the flow on or off of the freeway at an on- or off-ramp, respectively, per the modified macroscopic flow model
Volume	Implements the formula for volume
Volume2	Implements the formula for volume, linearized about a set-point

APPENDIX B

CONVERSION OF EMBEDDED CONSTANTS

During the initial phase of the MILOS research, a number of parameters were embedded in the code and “hard-wired”. Over the course of this research, most of those hard-coded parameters have been converted to variables and initialized in the `set_parameters.m` M-file. The following table lists the parameters that were converted:

<code>Num_timesteps_per_min</code>	Corresponds to the timestep length, default was 6 seconds, but changed to 12 seconds for I-10
<code>Start_graph_time</code>	Time after beginning of simulation to begin collecting statistics for graphing the results at the end
<code>Rmin</code>	Minimum ramp metering rate (one lane)
<code>Rmax</code>	Maximum ramp metering rate (one lane)
<code>Cap_buffer</code>	Percentage of the full capacity to use in solution of the upper-level AWCOP
<code>Ells</code>	Parameter of the speed-density characteristic converted to variable by location (segment)
<code>Emms</code>	Parameter of the speed-density characteristic converted to variable by location (segment)

APPENDIX C

EXAMPLE OUTPUT FROM TI SIMULATOR/QUEUE ESTIMATOR

As described in Section 4.2.1, the queue estimator uses information from the flows at the traffic intersection to estimate the number of vehicles entering the on-ramp during a time interval. This information will be necessary in integrating traffic interchange information into the MILOS software. This appendix shows an example of the output of the queue estimator.

```
After time interval 1
-----
Left Turners 0
Right Turners 0
Thru Traffic 0
Total No of cars entering ramp 0
Rate for Last Time Interval 0.000000
Rate for Last Three Time Interval 0.000000

After time interval 2
-----
Left Turners 0
Right Turners 0
Thru Traffic 0
Total No of cars entering ramp 0
Rate for Last Time Interval 0.000000
Rate for Last Three Time Interval 0.000000

After time interval 3
-----
Left Turners 0
Right Turners 0
Thru Traffic 0
Total No of cars entering ramp 0
Rate for Last Time Interval 0.000000
Rate for Last Three Time Interval 0.000000

After time interval 4
-----
Left Turners 0
Right Turners 0
Thru Traffic 0
Total No of cars entering ramp 0
Rate for Last Time Interval 0.000000
Rate for Last Three Time Interval 0.000000

After time interval 5
-----
Left Turners 1
Right Turners 1
Thru Traffic 0
Total No of cars entering ramp 2
Rate for Last Time Interval 0.100000
Rate for Last Three Time Interval 0.033333

After time interval 6
-----
Left Turners 1
```

Right Turners 2
Thru Traffic 0
Total No of cars entering ramp 3
Rate for Last Time Interval 0.150000
Rate for Last Three Time Interval 0.083333

After time interval 7

Left Turners 4
Right Turners 1
Thru Traffic 0
Total No of cars entering ramp 5
Rate for Last Time Interval 0.250000
Rate for Last Three Time Interval 0.166667

After time interval 8

Left Turners 1
Right Turners 1
Thru Traffic 0
Total No of cars entering ramp 2
Rate for Last Time Interval 0.100000
Rate for Last Three Time Interval 0.166667

After time interval 9

Left Turners 0
Right Turners 0
Thru Traffic 0
Total No of cars entering ramp 0
Rate for Last Time Interval 0.000000
Rate for Last Three Time Interval 0.116667

After time interval 10

Left Turners 1
Right Turners 1
Thru Traffic 0
Total No of cars entering ramp 2
Rate for Last Time Interval 0.100000
Rate for Last Three Time Interval 0.066667

After time interval 11

Left Turners 3
Right Turners 2
Thru Traffic 0
Total No of cars entering ramp 5
Rate for Last Time Interval 0.250000
Rate for Last Three Time Interval 0.116667

After time interval 12

Left Turners 3
Right Turners 2
Thru Traffic 0
Total No of cars entering ramp 5
Rate for Last Time Interval 0.250000
Rate for Last Three Time Interval 0.200000

After time interval 13

Left Turners 3

Right Turners 0
Thru Traffic 0
Total No of cars entering ramp 3
Rate for Last Time Interval 0.150000
Rate for Last Three Time Interval 0.216667

After time interval 14

Left Turners 1
Right Turners 1
Thru Traffic 0
Total No of cars entering ramp 2
Rate for Last Time Interval 0.100000
Rate for Last Three Time Interval 0.166667

After time interval 15

Left Turners 0
Right Turners 0
Thru Traffic 0
Total No of cars entering ramp 0
Rate for Last Time Interval 0.000000
Rate for Last Three Time Interval 0.083333

After time interval 16

Left Turners 2
Right Turners 2
Thru Traffic 0
Total No of cars entering ramp 4
Rate for Last Time Interval 0.200000
Rate for Last Three Time Interval 0.100000

After time interval 17

Left Turners 3
Right Turners 1
Thru Traffic 0
Total No of cars entering ramp 4
Rate for Last Time Interval 0.200000
Rate for Last Three Time Interval 0.133333

After time interval 18

Left Turners 2
Right Turners 0
Thru Traffic 0
Total No of cars entering ramp 2
Rate for Last Time Interval 0.100000
Rate for Last Three Time Interval 0.166667

After time interval 19

Left Turners 2
Right Turners 1
Thru Traffic 0
Total No of cars entering ramp 3
Rate for Last Time Interval 0.150000
Rate for Last Three Time Interval 0.150000

After time interval 20

Left Turners 1

Right Turners 1
Thru Traffic 0
Total No of cars entering ramp 2
Rate for Last Time Interval 0.100000
Rate for Last Three Time Interval 0.116667

After time interval 21

Left Turners 3
Right Turners 1
Thru Traffic 0
Total No of cars entering ramp 4
Rate for Last Time Interval 0.200000
Rate for Last Three Time Interval 0.150000

After time interval 22

Left Turners 2
Right Turners 3
Thru Traffic 0
Total No of cars entering ramp 5
Rate for Last Time Interval 0.250000
Rate for Last Three Time Interval 0.183333

After time interval 23

Left Turners 2
Right Turners 1
Thru Traffic 0
Total No of cars entering ramp 3
Rate for Last Time Interval 0.150000
Rate for Last Three Time Interval 0.200000

After time interval 24

Left Turners 1
Right Turners 0
Thru Traffic 0
Total No of cars entering ramp 1
Rate for Last Time Interval 0.050000
Rate for Last Three Time Interval 0.150000

After time interval 25

Left Turners 3
Right Turners 2
Thru Traffic 0
Total No of cars entering ramp 5
Rate for Last Time Interval 0.250000
Rate for Last Three Time Interval 0.150000

After time interval 26

Left Turners 2
Right Turners 2
Thru Traffic 0
Total No of cars entering ramp 4
Rate for Last Time Interval 0.200000
Rate for Last Three Time Interval 0.166667

After time interval 27

Left Turners 2

Right Turners 1
Thru Traffic 0
Total No of cars entering ramp 3
Rate for Last Time Interval 0.150000
Rate for Last Three Time Interval 0.200000

After time interval 28

Left Turners 1
Right Turners 1
Thru Traffic 0
Total No of cars entering ramp 2
Rate for Last Time Interval 0.100000
Rate for Last Three Time Interval 0.150000

After time interval 29

Left Turners 2
Right Turners 1
Thru Traffic 0
Total No of cars entering ramp 3
Rate for Last Time Interval 0.150000
Rate for Last Three Time Interval 0.133333

After time interval 30

Left Turners 3
Right Turners 2
Thru Traffic 0
Total No of cars entering ramp 5
Rate for Last Time Interval 0.250000
Rate for Last Three Time Interval 0.166667

REFERENCES

- Asakura, Y., (1995) "LP Type Dynamic On-Ramp Traffic Control Model For Urban Expressway", Proceedings of 4th International Conference on Applications of Advanced Technologies in Transportation Engineering, June 27-30, 434-438.
- Banks, J., (1992) "Effect Of Response Limitations On Traffic-Responsive Ramp Metering", Transportation Research Record, 1394, 17-25.
- Gettman, D., (1998) "A Multiobjective Integrated Large-Scale Optimized Ramp Metering Control System For Freeway/Surface-Street Traffic Management", Ph.D. Thesis. University of Arizona.
- Gettman, D., Head, K.L., and Mirchandani, P.B., (1999), RHODES-ITMS Corridor Control Project, Final Report, FHWA-AZ99-462, Arizona Department of Transportation, Phoenix, Arizona, May 1999.
- Head, K., Mirchandani, P., and Sheppard, D., (1992) "Hierarchical Framework For Real-Time Traffic Control", Transportation Research Record, 1360, 82-88.
- Hibbard, J., et al., (1990) "An Overview of the Ramp Metering Subsystem for the Phoenix Freeway Management System", ITE 1990 Compendium of Technical Papers, 51-54.
- Lindley, J., (1987) "Urban Freeway Congestion: Quantification Of The Problem And Effectiveness Of Potential Solutions", ITE Journal, January, 27-32.
- Lindley, J., (1987) "A Methodology For Quantifying Urban Freeway Congestion", Transportation Research Record, 1132, 1-7.
- Marsden, B., (1981) "Ramp Meters And Travel Quality In Austin, Texas", Texas Department of Highways and Public Transportation, 27.
- Payne, H., Brown, D., Todd, J.,(1985) "Demand-Responsive Strategies for Interconnected Freeway Ramp Control Systems, Volume I: Metering Strategies", FHWA/RD-85/109, U.S. Department of Transportation, Washington, DC.
- Payne, H., and Thompson, W., (1974) "Allocation of Freeway Ramp Metering Volumes to Optimize Corridor Performance", IEEE Transactions on Automatic Control, AC-19, 3, 177-186.
- Zhang, H., Ritchie, S., and Lo, Z., (1995) "On The Optimal Control Problem: When Does Ramp Metering Work?", 74th Annual Meeting of the Transportation Research Board, Washington, DC.